

50/11 VF SPARE PARTS

Automatic horizontal sliding car door

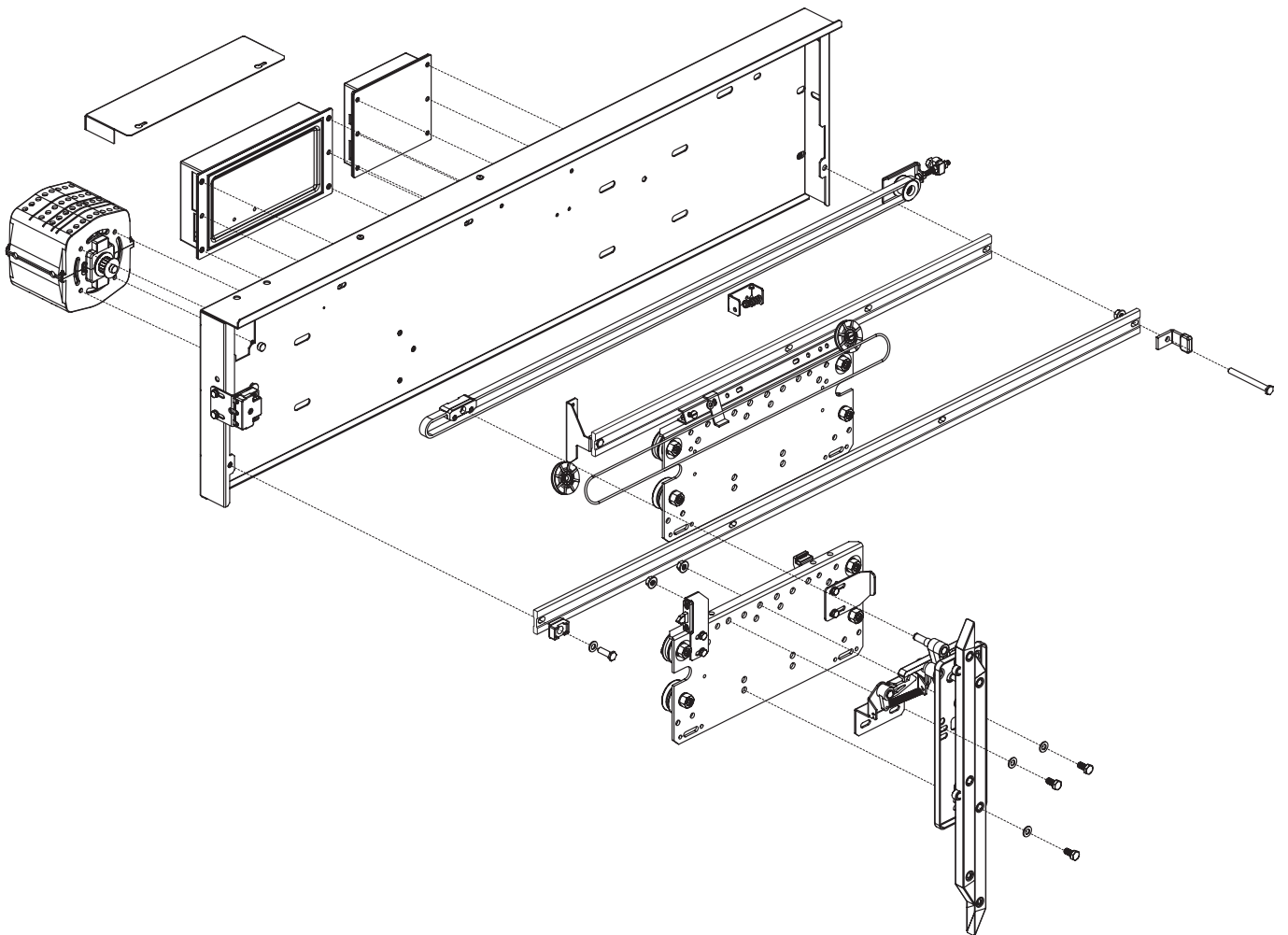

Multimedia design and production by Klefer.

KLEFER S.A.
KILKIS Business Park 61100
KILKIS (GREECE)
Tel.: +30 23410 75730 - 2
Email: commercial@klefer.com
General Commercial Register (GEMI): 014504535000
National Producers Register Nr.: 2581



- Spare part in stock: Available with a minimal period of delivery.



- Spare parts to be manufactured: Need to be fabricated and therefore requires a longer delivery period.

Klefer reserves the right to modify the specification and price of the products in this catalogue without prior notice.

Rate revision according version.
The rates are valid except for typographical mistakes.
The price of packaging is not included.
IVA or VAT not included.

1.1

DOOR OPERATOR

Traction parts



CMT Motor



Code	Description
CMT.VF0002	IP21 model without encoder and pulley HTD.
CMT.VFE001	IP21 model with encoder and pulley HTD.
CMT.VF0005	IP54 model without encoder and pulley HTD.
CMT.VFE004	IP54 model with encoder and pulley HTD.
CMT.VFE007	IP54 increased safety model with encoder and pulley HTD.
CMT.VFE006	IP65 model with encoder and pulley HTD.
CMT.VF0067	IP21 model without encoder and thermal protection and pulley HTD.
CMT.VFE066	IP21 model with encoder and thermal protection and pulley HTD.
CMT.VF00AB	IP54 model without encoder and thermal protection and pulley HTD.
CMT.VFE0AA	IP54 model with encoder and thermal protection and pulley HTD.

VMT Encoder

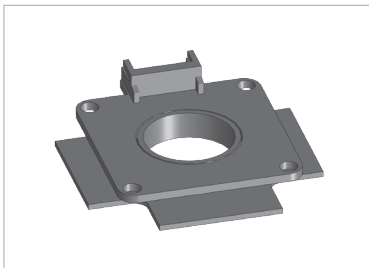

Code	Description
VMT.VFEN.C0000	Encoder.

PPM Motor pulley

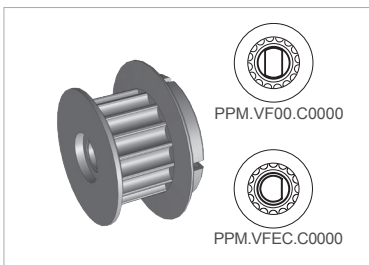

Code	Description
PPM.VF00.C0000	With standard axis (until march 2010).
PPM.VFEC.C0000	With conical axis (from march 2010).

HOC  **Motor support**

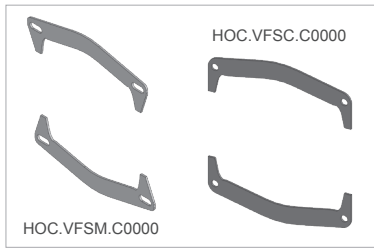

Code	Description
HOC.VFSC.C0000	Motor support without regulation VF (2 units).
HOC.VFSM.C0000	Motor support with regulation VF (Double motor) (2 units).

CHT  **Toothed belt base assembly**

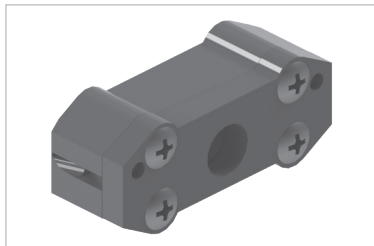

Code	Description
CHT.VFRF.C0000	Toothed belt base assembly HTD (Reinforced).

BHT  **RPP5 toothed belt by opening door**



Code	Description
BHT.VFRP.CC200 <input type="text" value="1"/>	C2.
BHT.VFRP.CC400 <input type="text" value="1"/>	C4.
BHT.VFRP.CC600 <input type="text" value="1"/>	C6.
BHT.VFRP.CC800 <input type="text" value="1"/>	C8.
BHT.VFRP.CT100 <input type="text" value="1"/>	T1.
BHT.VFRP.CT200 <input type="text" value="1"/>	T2.
BHT.VFRP.CT300 <input type="text" value="1"/>	T3.
BHT.VFRP.CT400 <input type="text" value="1"/>	T4.

 To complete this code, see annexe 1 (Clear opening table). The price shown is valid for CO 800 mm.

BHT  **RPP5 toothed belt by meters**



Code	Description
BHT.VFRP.C0000 <input type="text" value="Quantity"/>	Toothed belt RPP5.

 In Quantity field, show the meters needed preceded by 0 until complete 4 figures.
The price shown is valid for one meter.

1.2

DOOR OPERATOR

Synchronization



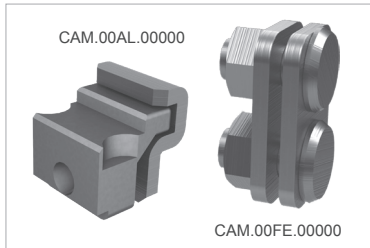

CAM Cable fastener assembly

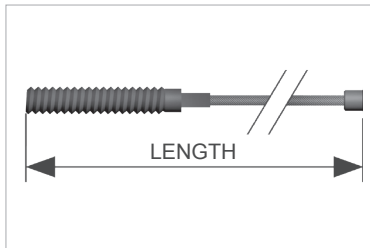

Code	Description
CAM.00AL.00000	Cable fastener assembly.
CAM.00FE.00000	Cable fastener assembly.

PCA Synchronization wire



Code	Description
PCA.0000. 	Synchronization wire.
 To complete this code, see annexe 2 (Synchronization wire length by clear opening table). The price shown is valid for one meter.	

PPR Idle pulley

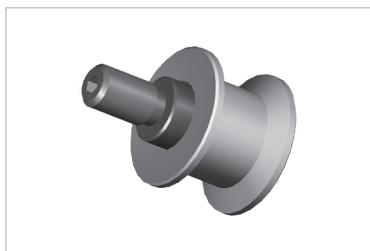

Code	Description
PPR.VF00.C0000	Idle pulley.

CPR Idle pulley tensor assembly

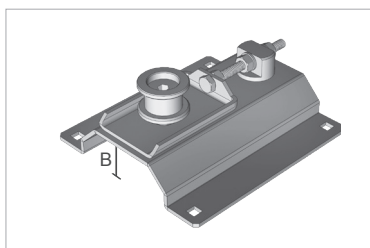

Code	Description
CPR.VF54.CC200	54 mm sill.
CPR.VF90.CC400	C4 90 mm sill. B: 35 mm.
CPR.VF90.C0000	T2 90 mm sill. B: 35 mm.
CPR.VF13.CT3ST	T3 CO < 1000 mm 135 mm sill. B: 75 mm.
CPR.VF13.CT300	T3 CO ≥ 1000 mm 135 mm sill. B: 75 mm.
CPR.VF00.CT400	T4 180 mm sill.

 For 54 mm sill assembly is supplied without support.

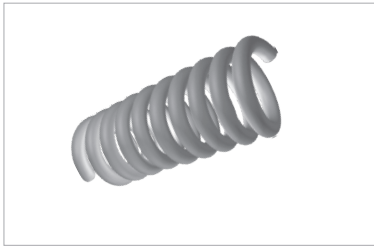
RCA  **Tensor spring for synchronization wire**

Code

RCA.0000.C0015.00330.925FG.0250

Description

Tensor spring for synchronization wire.

1.3

DOOR OPERATOR

Acting parts



CSK



Clutch assembly



Code	Description
CSK.VF00.CD000	Standard. Right opening and central opening with double locking device.
CSK.VF00.CI000	Standard. Left and central opening.
CSK.VFES.CC400	C4. CO:600.
CSK.VF00.CC400	C4. CO 650 - 915 mm.
CSK.D005.CD000	Displaced 50 mm. Right opening.
CSK.D005.CI000	Displaced 50 mm. Left opening.
CSK.D010.CD000	Displaced 100 mm. Right opening.
CSK.D010.CI000	Displaced 100 mm. Left opening.
CSK.D015.CD000	Displaced 150 mm. Right opening.
CSK.D015.CI000	Displaced 150 mm. Left opening.
CSK.ESA1.CD000	Action area 100 mm. Right opening.
CSK.ESA1.CI000	Action area 100 mm. Left opening.
CSK.VF00.CD400	T4. CO:650-900. Right opening.
CSK.VF00.CI400	T4. CO:650-900. Left opening.
CSK.VFDR.CC612	C6. CO:1200. Right opening.
CSK.VFDR.CC613	C6. CO:1300. Right opening.
CSK.VFDR.CC614	C6. CO:1400-1800. Right opening.
CSK.VFDR.CC800	C8. CO:1400-2300. Right opening.
CSK.VFIZ.CC612	C6. CO:1200. Left opening.
CSK.VFIZ.CC613	C6. CO:1300. Left opening.
CSK.VFIZ.CC614	C6. CO:1400-1800 Left opening. & C4 CO:1100.
CSK.VFIZ.CC800	C8. CO:1400-2300. Left opening.
CSK.VFCD.CD000	Standard with spring. C4 CO ≥ 1200, C6-C8.
CSK.VFDM.CD000	Standard with spring. Arm 560. C4 CO ≥ 1200, C6-C8.

CSL



Car locking device assembly

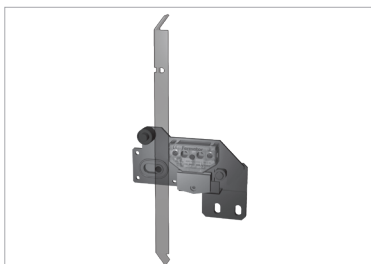

Code	Description
CSL.5000.CC200	C2 54 mm sill.
CSL.50IP.CC200	C2 IP54 54mm sill.
CSL.5000.CC400	C4 90 mm sill.
CSL.5000.CD200	T2 90 mm sill. Right opening.
CSL.5000.CI200	T2 90 mm sill. Left opening.
CSL.5000.CD300	T3 135 mm sill. Right opening.
CSL.5000.CI300	T3 135 mm sill. Left opening.

CSK

Q model clutch assembly for special height cars

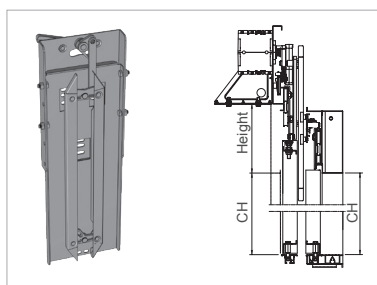

Code	Description
CSK.Q001.CD000	Displaced 100 mm. Height: 320 mm. Right opening.
CSK.Q002.CD000	Displaced 150 mm. Height: 370 mm. Right opening.
CSK.Q003.CD000	Displaced 200 mm. Height: 420 mm. Right opening.
CSK.Q004.CD000	Displaced 250 mm. Height: 470 mm. Right opening.
CSK.Q005.CD000	Displaced 300 mm. Height: 520 mm. Right opening.
CSK.Q006.CD000	Displaced 350 mm. Height: 570 mm. Right opening.
CSK.Q007.CD000	Displaced 400 mm. Height: 620 mm. Right opening.
CSK.Q008.CD000	Displaced 450 mm. Height: 670 mm. Right opening.
CSK.Q009.CD000	Displaced 500 mm. Height: 720 mm. Right opening.
CSK.Q010.CD000	Displaced 550 mm. Height: 770 mm. Right opening.
CSK.Q011.CD000	Displaced 600 mm. Height: 820 mm. Right opening.
CSK.Q012.CD000	Displaced 650 mm. Height: 870 mm. Right opening.
CSK.Q013.CD000	Displaced 700 mm. Height: 920 mm. Right opening.
CSK.Q014.CD000	Displaced 750 mm. Height: 970 mm. Right opening.
CSK.Q015.CD000	Displaced 800 mm. Height: 1.020 mm. Right opening.
CSK.Q016.CD000	Displaced 850 mm. Height: 1.070 mm. Right opening.
CSK.Q001.CI000	Displaced 100 mm. Height: 320 mm. Left opening.
CSK.Q002.CI000	Displaced 150 mm. Height: 370 mm. Left opening.
CSK.Q003.CI000	Displaced 200 mm. Height: 420 mm. Left opening.
CSK.Q004.CI000	Displaced 250 mm. Height: 470 mm. Left opening.
CSK.Q005.CI000	Displaced 300 mm. Height: 520 mm. Left opening.
CSK.Q006.CI000	Displaced 350 mm. Height: 570 mm. Left opening.
CSK.Q007.CI000	Displaced 400 mm. Height: 620 mm. Left opening.
CSK.Q008.CI000	Displaced 450 mm. Height: 670 mm. Left opening.
CSK.Q009.CI000	Displaced 500 mm. Height: 720 mm. Left opening.
CSK.Q010.CI000	Displaced 550 mm. Height: 770 mm. Left opening.
CSK.Q011.CI000	Displaced 600 mm. Height: 820 mm. Left opening.
CSK.Q012.CI000	Displaced 650 mm. Height: 870 mm. Left opening.
CSK.Q013.CI000	Displaced 700 mm. Height: 920 mm. Left opening.
CSK.Q014.CI000	Displaced 750 mm. Height: 970 mm. Left opening.
CSK.Q015.CI000	Displaced 800 mm. Height: 1.020 mm. Left opening.
CSK.Q016.CI000	Displaced 850 mm. Height: 1.070 mm. Left opening.

CDL

Contact and lock clutch assembly

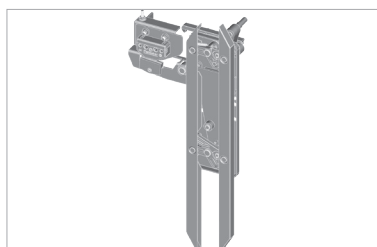

Code	Description
CDL.VF00.CC200	C2.
CDL.5000.CC400	C4 CO 600 - 900 mm 90 mm sill.
CDL.VF00.CC400	C4 CO 950 - 1100 mm 90 mm sill.
CDL.5070.CC400	C4 CO 600 - 900 mm 70 mm sill.
CDL.VFES.CC400	C4 CO \geq 1150 mm 90 mm sill.
CDL.VF00.CC600	C6.
CDL.VF00.CC800	C8.
CDL.VF00.CD000	T1, T2, T3, T4. Right opening.
CDL.VF00.CI000	T1, T2, T3, T4. Left opening.
CDL.VF58.CC200	C2. Arm 580 mm.
CDL.5058.CC400	C4. Arm 580 mm. CO:600-900.
CDL.VF58.CC401	C4. Arm 580mm. CO:950-1100 mm.
CDL.VF58.CC400	C4. Arm 580mm. CO \geq 1150 mm.
CDL.VF58.CC600	C6. Arm 580 mm.
CDL.VF58.CD000	T1, T2, T3, T4. Arm 580 mm. Right opening.
CDL.VF58.CI000	T1, T2, T3, T4. Arm 580 mm. Left opening.



In case of CDL IP54 please contact with Commercial sales.

KDM Manual unlocking device



Code	Description
KDM.50.00.C.0D. KO PH	(CDL). Right opening.
KDM.50.00.C.0I. KO PH	(CDL). Left & central opening.

 To complete this code, **KO** refers to Extra Carriage, the code is 000 except Full Glass 50/11 VF, **PH** refers to Panel Height.

CTR Stopping retainer assembly

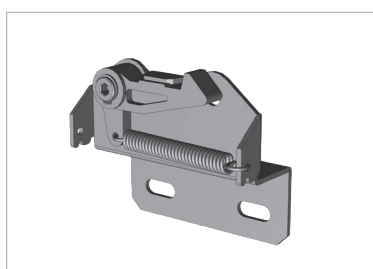

Code	Description
CTR.VF54.CD000	54 mm sill. T1 Right opening.
CTR.VF54.CI000	54 mm sill. T1 Left opening.
CTR.VF00.CD200	90 mm sill. T2 Right opening.
CTR.VF00.CI200	90 mm sill. T2 Left opening.
CTR.VF00.CD300	135 mm sill T3, 180 mm sill T4 Right opening.
CTR.VF00.CI300	135 mm sill T3, 180 mm sill T4 Left opening.
CTR.VF54.CC200	54 mm sill C2.
CTR.VF90.CC400	90 mm sill C4, CO: 600 - 900 mm.
CTR.VF91.CC400	90 mm sill C4, CO: 950 - 1150 mm.
CTR.VF92.CC400	90 mm sill C4, CO > 1150 mm.
CTR.VF13.CC600	135 mm sill C6.
CTR.VF18.CC800	180 mm sill C8.

PTR Stopping retainer trigger



Code	Description
PTR.VF00.C0000	Stopping retainer trigger.

DSK Pulling trigger



Code	Description
DSK.VFGA.C0000	Pulling trigger.
DSK.00BA.C0000	Pulling rod.
DSK.VFCC.C0000	Pulling rod. CDL.

RSK Clutch assembly spring



Code	Description
RSK.VF00.C0000	Pulling trigger spring.

RSK Connecting rod spring



Code	Description
RSK.00BP.CD200	Right hand clutch.
RSK.00BP.CI200	Left hand clutch.

KLA Drive retractable cam kit

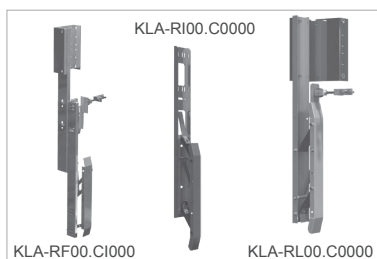

Code	Description
KLA.RF00.CD000 <input checked="" type="checkbox"/>	Frontal. Right hand (For left opening, hinged semiautomatic doors).
KLA.RF00.CI000 <input checked="" type="checkbox"/>	Frontal. Left hand (For right opening, hinged semiautomatic doors).
KLA.RI00.C0000 <input checked="" type="checkbox"/>	Inverted lateral retractable.
KLA.RL00.C0000 <input checked="" type="checkbox"/>	Lateral retractable.
KLA.RIA1.C0000 <input checked="" type="checkbox"/>	Inverted lateral retractable, acting zone 100 mm.

 Code X: Drive height in mm from the centre of the cam to the sill. If standard (1.850 mm), indicate 1850. For other heights increase in 100 by 100 mm.

KLA Drive fixed cam kit

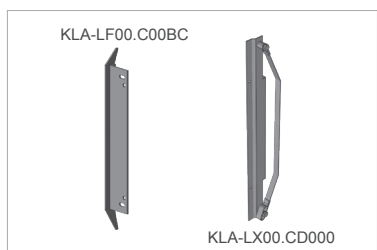

Code	Description
KLA.LF00.C00BC	Fixed.
KLA.LX00.CD000	Right flexible.
KLA.LX00.CI000	Left flexible.
KLA.LO00.C0000	Fixed type O.
KLA.LFCA.CC000	Fixed. Type C. Central opening.
KLA.LFA1.C00BC	Fixed. Unlocking 100 mm.

KLA**Landing cam assembly for car door lock with fixed cam**

Code	Descripción
KLA.00AE.RC000	Central opening with automatic landing door.
KLA.00AE.RD000	Right side opening with automatic landing door.
KLA.ECSE.R0000	Semiautomatic outside door.

1.4

DOOR OPERATOR

Carriages



PFR Wheel

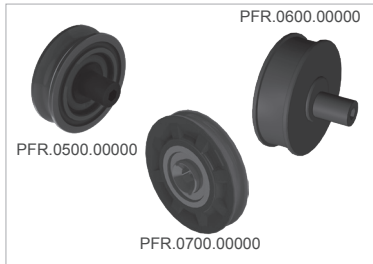

Code	Description
PFR.0500.00000	Concentric. PFR-05. Ø 56 mm.
PFR.0600.00000	Eccentric. PFR-06. Ø 54 mm.
PFR.0700.00000	Synchronization. PFR-07. External Ø 64 mm. Internal Ø 8 mm.

PBR Wheel carrier arm

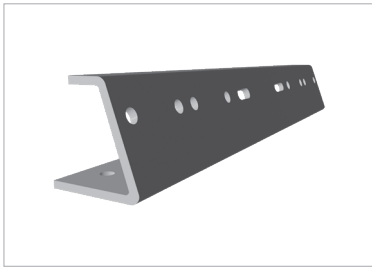

Code	Description
PBR.5000.CC4BC 	C4. Panel 40 mm.
PBR.5000.CC6BC 	C6. Panel 40 mm.
PBR.5000.CC8BC 	C8. Panel 40 mm.
PBR.5000.CT2BC 	T2. Panel 40 mm.
PBR.5000.CT3BC 	T3. Panel 40 mm.
PBR.5000.CT4BC 	T4. Panel 40 mm.

 To complete this code, see annexe 1 (Clear opening table). The price shown is valid for PL 800 mm.

PSA Carriage pulling support

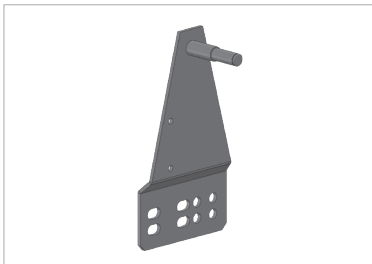

Code	Description
PSA.VF00.CC200	C2, T1. 54 mm sill.
PSA.VF00.CT200	T2 90 mm sill.
PSA.VF00.CT300	T3, C6 135 mm sill, T4, C8 180 mm sill, T3 CO ≥ 1.400 90 mm sill.
PSA.5000.CC400	C4 90 mm sill.

1.5

DOOR OPERATOR

Buffers



PTF End stroke stop

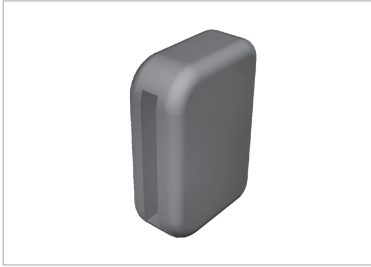

Code	Description
PTF.0000.C0000	End stroke stop.

DSK Rod rubber

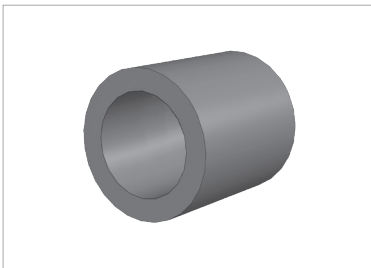

Code	Description
DSK.VFTB.C0000	Rod rubber.

PTG Rubber stop

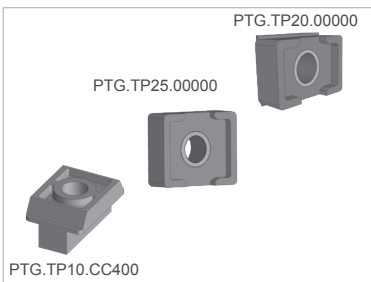

Code	Description
PTG.TP20.00000	20 x 30 mm stop.
PTG.TP25.00000	25 x 30 mm stop.
PTG.TP10.CC400	10 x 30 mm stop.

1.6

DOOR OPERATOR

Others



UHT



Belt regulation tool



Code

UHT.VF00.C0000

Description

Belt regulation tool.

AEC



Fastening bracket set



Code

AEC.VF00.C0000

Description

50/11 VF car operators (2 units).

2

ACCESSORIES



PPS Sill

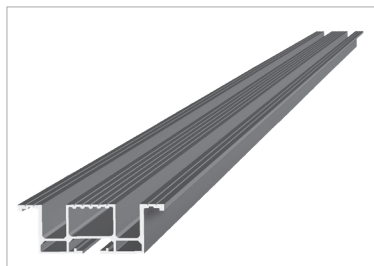

Code	Description
PPS. (14) . (3) . CC2. (1)	C2.
PPS. (14) . (3) . CC4. (1)	C4.
PPS. (14) . (3) . CC6. (1)	C6.
PPS. (14) . (3) . CC8. (1)	C8.
PPS. (14) . (3) . CR1. (1)	T1. Right opening.
PPS. (14) . (3) . CL1. (1)	T1. Left opening.
PPS. (14) . (3) . CR2. (1)	T2. Right opening.
PPS. (14) . (3) . CL2. (1)	T2. Left opening.
PPS. (14) . (3) . CR3. (1)	T3. Right opening.
PPS. (14) . (3) . CL3. (1)	T3. Left opening.
PPS. (14) . (3) . CR4. (1)	T4. Right opening.
PPS. (14) . (3) . CL4. (1)	T4. Left opening.
PPS. (14) . (3) . CT2. (1)	T2. CO: 700, 800, 900. EN 81-20/50.

 For sill without dust holes in telescopic doors the code is completed with T. (For either Left or Right opening, sill is the same).

To complete this code, see annex 1 (Clear opening table), annex 3 (Sill options) and annex 14 (Sill materials, finishes and dimension table). The price shown is valid for PL 800 mm.

PAC Sill support

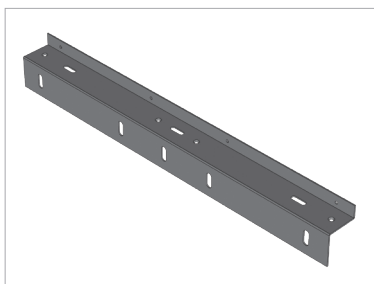



Code	Description
PAC.CO54.CC2IM 	For 54 mm sill, with evacuation slots.
PAC.HM54.CC2IM 	For 54 mm solid iron sill, with evacuation slots.
PAC.CO90.CT2IM 	For 90 mm sill, with evacuation slots.
PAC.HM90.CT2IM 	For 90 mm solid iron sill, with evacuation slots.
PAC.CO13.CT3IM 	For 135 mm sill, with evacuation slots.
PAC.HM13.CT3IM 	For 135 mm solid iron sill, with evacuation slots.
PAC.CO18.CT4IM 	For 180 mm sill, with evacuation slots.
PAC.HM18.CT4IM 	For 180 mm solid iron sill, with evacuation slots.

 To complete this code, see annexe 1 (Clear opening table). The price shown is valid for PL 800 mm.

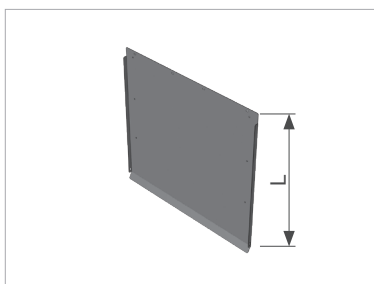
PFA Toe guard



Code	Description
PFA.GM00.C00IM 	L: 750 mm. Epoxy.
PFA.GM00.C00XN 	L: 750 mm. Stainless steel.

 To complete this code, see annexe 1 (Clear opening table). The price shown is valid for PL 800 mm.

3

PANELS



ASH Carriage supplement



Code	Description
ASH.GM10.C0000	100 mm with fasteners (2 units).
ASH.GM15.C0000	150 mm with fasteners (2 units).

ASH Panel regulator support

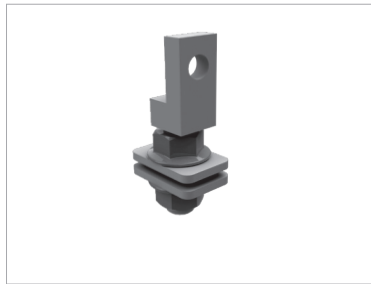

Code	Description
ASH.0001.C0000	60 mm. (2 units).
ASH.0002.C0000	100 mm. (2 units).
ASH.0003.C0000	40 mm. (2 units).

AGH Panel guide shoe assembly

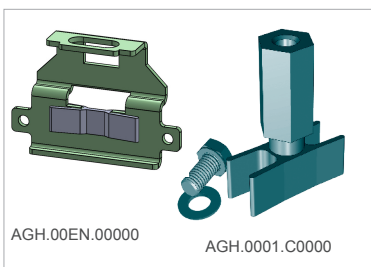

Code	Description
AGH.0001.C0000	16 mm groove (2 units).
AGH.0006.C0000	Full glass panel dating from before 2008 (2 units).
AGH.00EN.00000	8 mm groove. EN 81.20/50 (2 units).
AGH.DAA000000	8 mm groove. Type ADVANCED AGH-DA (Release II) EN 81.20/50 (2 units).

GFH Glass



Code	Description
GFH.GMB0.00000	Dimension X1 Dimension Y1 Laminated glass. Beveled big vision 5+5.
GFH.GME2.00000	Dimension X2 Dimension Y1 Laminated glass. Flush big vision 6 + 6.

! **Code Dimension X1:** PL / number of panels - 40 mm. **Code Dimension Y1:** HL - 200 mm.
Code Dimension X2: PL / number of panels - 47 mm. **Code Dimension Y1:** HL - 200 mm.
Note: In case of obtaining a value of three figures, precede by 0 to complete the code.
The price shown is valid for glass measurements T2, PL 800 mm and HL 2.000 mm, with a ratio of X and Y = 1.

4

ELECTRONIC COMPONENTS

WCE  Electrical wiring

Code	Description
WCE.SRSC.S20HK.0550	Series. Without circuit. L: 550 mm.
WCE.SRSC.S20HK.0885	Series. Without circuit. L: 885 mm.
WCE.AM00.S42HK.2520	Motor extension. L: 2.520 mm.
WCE.AM00.S42HK.4020	Motor extension. L: 4.020 mm.
WCE.EN00.S42A4.0500	Encoder. L: 500 mm.
WCE.CB00.S21HK.0450	Battery connection. L: 450 mm.

CFT  Optical safety devices

Code	Description
CFT.FC00.C0000	Photocell. 3.000 mm wire length.
CFT.FCDM.C0000	Photocell. 5.000 mm wire length.

KCE  Electrical contact kit

Code	Description
KCE.A4A5.00000	Astra AS 011.
KCE.40CS.00000	40 mm.
KCE.5000.00000	50 mm.
KCE.6040.00000	60 mm.
KCE.IP54.00000	IP54 contact.

BCV |  Connector

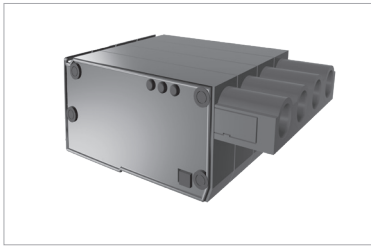

Code	Description
BCV.CO00.S0502	5 mm and 2 paths.
BCV.CO00.S0504	5 mm and 4 paths.
BCV.CO00.S0505	5 mm and 5 paths.
BCV.CO00.S0512	5 mm and 12 paths.
BCV.CO00.S103H	10 mm and 3 paths.

VCI |  VF5+ Electronic module



Code	Description
VCI.V05P.0010.0FLGE	10 Ohms. EN 81-1/2. Left opening. Greek - English.
VCI.V05P.0010.0FRGE	10 Ohms. EN 81-1/2. Right opening. Greek - English.
VCI.V05P.0010.0FLTE	10 Ohms. EN 81-1/2. Left opening. Turkish - English.
VCI.V05P.0010.0FRTE	10 Ohms. EN 81-1/2. Right opening. Turkish - English.
VCI.V05P.0E10.0FLGE	10 Ohms. EN 81-20/50. Left opening. Greek - English.
VCI.V05P.0E10.0FRGE	10 Ohms. EN 81-20/50. Right opening. Greek - English.
VCI.V05P.0E10.0FLTE	10 Ohms. EN 81-20/50. Left opening. Turkish - English.
VCI.V05P.0E10.0FRTE	10 Ohms. EN 81-20/50. Right opening. Turkish - English.

VCI |  VF7+ Relay Electronic module



Code	Description
VCI.V07P.0E10.0FLGE	10 Ohms. EN 81.20/50. Left opening. Greek - English.
VCI.V07P.0E10.0FRGE	10 Ohms. EN 81.20/50. Right opening. Greek - English.
VCI.V07P.0E10.0FLTE	10 Ohms. EN 81.20/50. Left opening. Turkish - English.
VCI.V07P.0E10.0FRTE	10 Ohms. EN 81.20/50. Right opening. Turkish - English.

VCI |  VF7+ CAN Electronic module



Code	Description
VCI.V07P.0E1P.0FLEE	Type CAN . EN 81.20/50. Left opening. Spanish - English.
VCI.V07P.0E1P.0FREE	Type CAN . EN 81.20/50. Right opening. Spanish - English.

VCI Emergency power supply



Code	Description
VCI.AESB.C00GE	Without battery. Greek - English.
VCI.AESB.C00TE	Without battery. Turkish - English.

COE Battery



Code	Description
COE.BAT0.2A000	12 V. 2 A.

COE Fuse

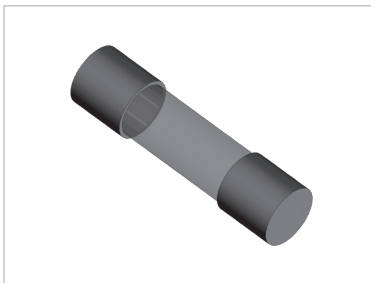

Code	Description
COE.FU4A.00000	4 A ceramic fuse.

VCP Programming console



Code	Description
VCP.VFCP.C00EN	Programming console. English language.

5

ANNEXES



1

CLEAR OPENING TABLE

CO	CODE	RATIO	CO	CODE	RATIO
500	0500	1,00	2.250	2250	2,81
550	0550	1,00	2.300	2300	2,88
600	0600	1,00	2.350	2350	2,94
650	0650	1,00	2.400	2400	3,00
700	0700	1,00	2.450	2450	3,06
750	0750	1,00	2.500	2500	3,13
800	0800	1,00	2.550	2550	3,19
850	0850	1,06	2.600	2600	3,25
900	0900	1,13	2.650	2650	3,31
915	0915	1,14	2.700	2700	3,38
950	0950	1,19	2.750	2750	3,44
1.000	1000	1,25	2.800	2800	3,50
1.050	1050	1,31	2.850	2850	3,56
1.100	1100	1,38	2.900	2900	3,63
1.150	1150	1,44	2.950	2950	3,69
1.200	1200	1,50	3.000	3000	3,75
1.250	1250	1,56	3.050	3050	3,81
1.300	1300	1,63	3.100	3100	3,88
1.350	1350	1,69	3.150	3150	3,94
1.400	1400	1,75	3.200	3200	4,00
1.450	1450	1,81	3.250	3250	4,06
1.500	1500	1,88	3.300	3300	4,13
1.550	1550	1,94	3.350	3350	4,19
1.600	1600	2,00	3.400	3400	4,25
1.650	1650	2,06	3.450	3450	4,31
1.700	1700	2,13	3.500	3500	4,38
1.750	1750	2,19	3.550	3550	4,44
1.800	1800	2,25	3.600	3600	4,50
1.850	1850	2,31	3.650	3650	4,56
1.900	1900	2,38	3.700	3700	4,63
1.950	1950	2,44	3.750	3750	4,69
2.000	2000	2,50	3.800	3800	4,75
2.050	2050	2,56	3.850	3850	4,81
2.100	2100	2,63	3.900	3900	4,88
2.150	2150	2,69	3.950	3950	4,94
2.200	2200	2,75	4.000	4000	5,00

To determine the final price it is necessary to multiply the base price by the ratio in the table.

2

SYNCHRONIZATION WIRE LENGTH BY CLEAR OPENING TABLE

CO	CODE / LENGTH							
	C2	C4 ⁽¹⁾	C4 ⁽²⁾	C6	C8	T2	T3	T4
600 SE*	02380	01880	00860	-	-	01080	00860	-
600 AE*	02380	01920	00680	-	-	01080	00860	-
650	02480	02020	00725	-	-	01180	00860	00760
700	02580	02180	00760	-	-	01180	00960	00760
750	02680	02320	00810	-	-	01280	00960	00810
800	02780	02480	00810	-	-	01280	01010	00860
850	02880	02620	00810	-	-	01380	01010	00860
900	02980	02780	00910	-	-	01380	01080	00910
950	03080	02910	00960	-	-	01480	01080	00910
1.000	03180	03080	01010	-	-	01480	01180	00960
1.100	03380	03380	01080	00810	-	01580	01280	01010
1.200	03580	-	01140	00810	00710	01680	01280	01060
1.300	03780	-	01180	00860	00760	01780	01380	01110
1.400	03980	-	01180	00960	00760	01880	01480	01180
1.500	04180	-	01280	01010	00810	01980	01480	01280
1.600	04380	-	01380	01010	00810	02080	01580	01280
1.700	-	-	01380	01080	00860	02180	01680	01380
1.800	-	-	01380	01080	00910	02280	01680	01380
1.900	-	-	01480	01180	00960	02380	01780	01480
2.000	-	-	01480	01180	00960	02480	01880	01480
2.100	-	-	01580	01180	01010	-	01880	-
2.200	-	-	01580	01280	01010	-	01980	-
2.300	-	-	01680	01280	01080	-	02080	-
2.400	-	-	01680	01280	01080	-	02080	-
2.500	-	-	01780	01380	01080	-	-	-
2.600	-	-	01780	01380	01110	-	-	-
2.700	-	-	01880	01480	01140	-	-	-
2.800	-	-	01880	01480	01180	-	-	-
2.900	-	-	01980	01480	01180	-	-	-
3.000	-	-	01980	01580	01280	-	-	-

• To determine the final price it is necessary to multiply the length x 0,0097.

(1) The dimension is for the synchronization wire between opposite sides of hanger plates.

(2) The dimension is for the synchronization wire between fast and slow hanger plates.

SE: Semiautomatic landing door.

AE: Automatic landing door.

3

SILL OPTIONS

SILL TYPE	CODE	Increase in the final price (€)
With dust holes	0A	6,30 €
Without dust holes	00	-
Heated with dust holes	HA	241,37 €
Heated without dust holes	H0	241,37 €
Cut for semiautomatic outside with dust holes	RA	75 €
Cut for semiautomatic outside without dust holes	RO	75 €
Cut for cabin frame with dust holes*	CA	75 €
Cut for cabin frame without dust holes*	CO	75 €

* Only for Telescopic doors.

14

SILL MATERIALS, FINISHES AND DIMENSION TABLE

MATERIAL	AISI	OPENING	CHANNEL	CODE	DESCRIPTION	HEATED OPTION	RATIO	
Aluminium	-	C2 - T1	8,2 mm	AL054008	54 mm. Panels 50 mm.	Available	1,00	
		C4 - T2		AL090008	90 mm. Panels 40 + 40 mm.		1,00	
		C6 - T3	14,8 mm	AL135015	135 mm. Panels 40 + 40 + 40 mm.		1,00	
				AL135008	135 mm. Panels 40 + 40 + 40 mm.		1,00	
Reinforced aluminium	-	C8 - T4	8,2 mm	AL180008	180 mm. Panels 40 + 40 + 40 + 40 mm.		Not available	1,00
		C2 - T1		AR054008	54 mm. Panels 50 mm.			1,50
		C4 - T2	AR090008	90 mm. Panels 40 + 40 mm.	1,50			
		C6 - T3	14,8 mm	AR135015	135 mm. Panels 40 + 40 + 40 mm.			1,50
AR135008	135 mm. Panels 40 + 40 + 40 mm.			1,50				
Solid iron	-	C8 - T4	8,2 mm	AR180008	180 mm. Panels 40 + 40 + 40 + 40 mm.	Available		1,50
		C2 - T1		HM054015	54 mm. Panels 50 mm.			6,80
		C4 - T2	HM090015	90 mm. Panels 40 + 40 mm.	6,80			
		C6 - T3	14,8 mm	HM135015	135 mm. Panels 40 + 40 + 40 mm.		6,80	
HM180015	180 mm. Panels 40 + 40 + 40 + 40 mm.			6,80				
Solid stainless steel	-	C2 - T1	14,8 mm	XM054015	54 mm. Panels 50 mm.		Not available	9,75
		C4 - T2		XM090015	90 mm. Panels 40 + 40 mm.			9,75
		C6 - T3		XM135015	135 mm. Panels 40 + 40 + 40 mm.			9,75
		C8 - T4		14,8 mm	XM180015	180 mm. Panels 40 + 40 + 40 + 40 mm.		9,75
C2 - T1	HC054015				54 mm. Panels 50 mm.	Available		4,30
C4 - T2	HC090015	90 mm. Panels 40 + 40 mm.		4,30				
C6 - T3	HC135015	135 mm. Panels 40 + 40 + 40 mm.		4,30				
Iron metal sheet	-	C8 - T4		HC180015	180 mm. Panels 40 + 40 + 40 + 40 mm.			4,30
		C2 - T1	XC054015	54 mm. Panels 50 mm.	Available		7,07	
		C4 - T2	XC090015	90 mm. Panels 40 + 40 mm.			7,07	
		C6 - T3	XC135015	135 mm. Panels 40 + 40 + 40 mm.			7,07	
Stainless steel metal sheet	304	C8 - T4	XC180015	180 mm. Panels 40 + 40 + 40 + 40 mm.			7,07	

NOTE: In case of EN 81.20/50 Release II complete at the end of the code R2. (From October 2020)

To determine the final price it is necessary to multiply the base price by the ratio in the table.



Enquiry: Order:

Order N°: Date: / / Delivery date: / /

Customer:

Delivery adress:

SPARE PARTS ORDER

QUANTITY	<input type="text"/> - <input type="text"/> <input type="text"/> <input type="text"/> <input type="text"/> <input type="text"/> <input type="text"/> <input type="text"/> <input type="text"/> <input type="text"/> <input type="text"/>	NOTES	<input type="text"/>
QUANTITY	<input type="text"/> - <input type="text"/> <input type="text"/> <input type="text"/> <input type="text"/> <input type="text"/> <input type="text"/> <input type="text"/> <input type="text"/> <input type="text"/> <input type="text"/>	NOTES	<input type="text"/>
QUANTITY	<input type="text"/> - <input type="text"/> <input type="text"/> <input type="text"/> <input type="text"/> <input type="text"/> <input type="text"/> <input type="text"/> <input type="text"/> <input type="text"/> <input type="text"/>	NOTES	<input type="text"/>
QUANTITY	<input type="text"/> - <input type="text"/> <input type="text"/> <input type="text"/> <input type="text"/> <input type="text"/> <input type="text"/> <input type="text"/> <input type="text"/> <input type="text"/> <input type="text"/>	NOTES	<input type="text"/>
QUANTITY	<input type="text"/> - <input type="text"/> <input type="text"/> <input type="text"/> <input type="text"/> <input type="text"/> <input type="text"/> <input type="text"/> <input type="text"/> <input type="text"/> <input type="text"/>	NOTES	<input type="text"/>
QUANTITY	<input type="text"/> - <input type="text"/> <input type="text"/> <input type="text"/> <input type="text"/> <input type="text"/> <input type="text"/> <input type="text"/> <input type="text"/> <input type="text"/> <input type="text"/>	NOTES	<input type="text"/>
QUANTITY	<input type="text"/> - <input type="text"/> <input type="text"/> <input type="text"/> <input type="text"/> <input type="text"/> <input type="text"/> <input type="text"/> <input type="text"/> <input type="text"/> <input type="text"/>	NOTES	<input type="text"/>
QUANTITY	<input type="text"/> - <input type="text"/> <input type="text"/> <input type="text"/> <input type="text"/> <input type="text"/> <input type="text"/> <input type="text"/> <input type="text"/> <input type="text"/> <input type="text"/>	NOTES	<input type="text"/>
QUANTITY	<input type="text"/> - <input type="text"/> <input type="text"/> <input type="text"/> <input type="text"/> <input type="text"/> <input type="text"/> <input type="text"/> <input type="text"/> <input type="text"/> <input type="text"/>	NOTES	<input type="text"/>
QUANTITY	<input type="text"/> - <input type="text"/> <input type="text"/> <input type="text"/> <input type="text"/> <input type="text"/> <input type="text"/> <input type="text"/> <input type="text"/> <input type="text"/> <input type="text"/>	NOTES	<input type="text"/>
QUANTITY	<input type="text"/> - <input type="text"/> <input type="text"/> <input type="text"/> <input type="text"/> <input type="text"/> <input type="text"/> <input type="text"/> <input type="text"/> <input type="text"/> <input type="text"/>	NOTES	<input type="text"/>
QUANTITY	<input type="text"/> - <input type="text"/> <input type="text"/> <input type="text"/> <input type="text"/> <input type="text"/> <input type="text"/> <input type="text"/> <input type="text"/> <input type="text"/> <input type="text"/>	NOTES	<input type="text"/>
QUANTITY	<input type="text"/> - <input type="text"/> <input type="text"/> <input type="text"/> <input type="text"/> <input type="text"/> <input type="text"/> <input type="text"/> <input type="text"/> <input type="text"/> <input type="text"/>	NOTES	<input type="text"/>
QUANTITY	<input type="text"/> - <input type="text"/> <input type="text"/> <input type="text"/> <input type="text"/> <input type="text"/> <input type="text"/> <input type="text"/> <input type="text"/> <input type="text"/> <input type="text"/>	NOTES	<input type="text"/>
QUANTITY	<input type="text"/> - <input type="text"/> <input type="text"/> <input type="text"/> <input type="text"/> <input type="text"/> <input type="text"/> <input type="text"/> <input type="text"/> <input type="text"/> <input type="text"/>	NOTES	<input type="text"/>
QUANTITY	<input type="text"/> - <input type="text"/> <input type="text"/> <input type="text"/> <input type="text"/> <input type="text"/> <input type="text"/> <input type="text"/> <input type="text"/> <input type="text"/> <input type="text"/>	NOTES	<input type="text"/>



Sales contacts

General: commercial@klefer.com

www.klefer.com