

PREMIUM SPARE PARTS

Automatic horizontal sliding landing door

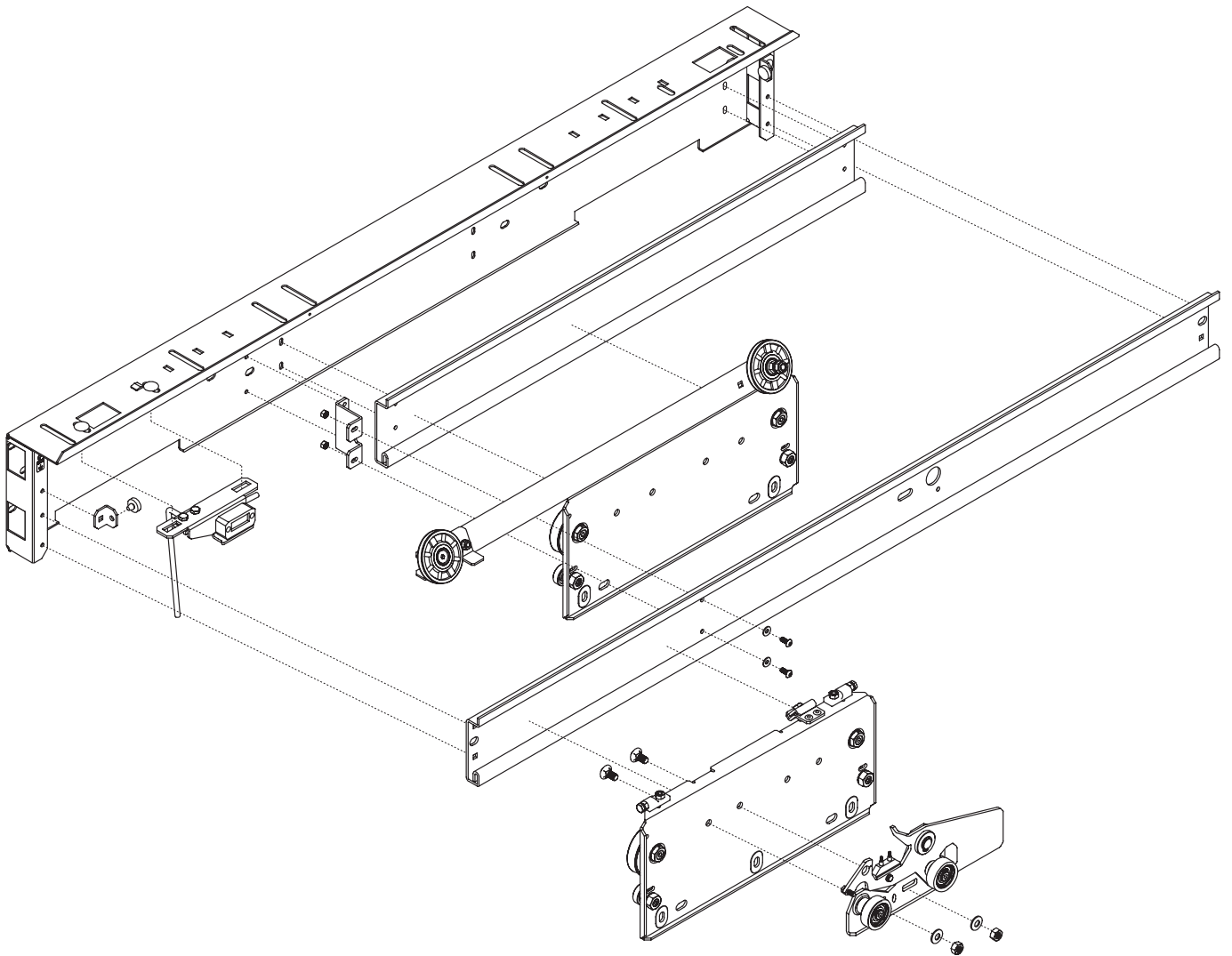

Multimedia design and production by Klefer.

KLEFER S.A.
KILKIS Business Park 61100
KILKIS (GREECE)
Tel.: +30 23410 75730 - 2
Email: commercial@klefer.com
General Commercial Register (GEMI): 014504535000
National Producers Register Nr.: 2581



- Spare part in stock: Available with a minimal period of delivery.



- Spare parts to be manufactured: Need to be fabricated and therefore requires a longer delivery period.

Klefer reserves the right to modify the specification and price of the products in this catalogue without prior notice.

Rate revision according version.
The rates are valid except for typographical mistakes.
The price of packaging is not included.
IVA or VAT not included.

1.1

DOOR MECHANISM

Locking devices



CSP Lock beak-plate support assembly

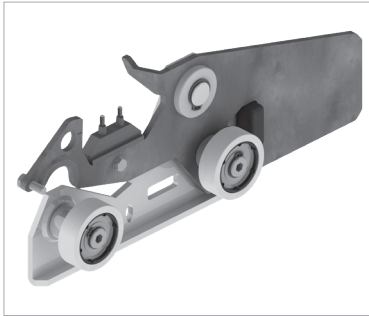

Code	Description
CSP.P3E1.RD000	C4 CO \leq 1.200 mm. Right hand.
CSP.P3E1.RI000	C2 CO \leq 850 mm, C4 CO \leq 1.200 mm. Left hand.
CSP.P300.RD000	C4 CO $>$ 1.200 mm, T2 . Right hand.
CSP.P300.RI000	C2 $>$ 850 mm, C4 CO $>$ 1.200 mm, T2 . Left hand.

 For central opening operators with double locking device, choose "right opening" or "left opening" according to the assembly hand needed. For central opening operators with a single locking device, choose "left opening".

CSC Lock contact support assembly



Code	Description
CSC.P300.RC200	C2.
CSC.P300.RD000	T2. Right hand.
CSC.P300.RI000	T2. Left hand.
CSC.P300.RC400	C4 CO $>$ 900 mm $<$ 1.200 mm.
CSC.P3ER.RC400	C4 CO 700 - 900 mm.
CSC.P3PD.RC400	C4 CO $>$ 1.200 mm.
CSC.P3IP.RC200	C2. IP54 Contact.

 For central opening operators with double locking device, choose "telescopic right opening" or "telescopic left opening" according to the assembly hand needed.

1.1 Locking devices

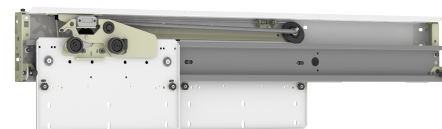

KEN



Lock assembly kit

NO IMAGE
AVAILABLE

Code	Description
KEN.P370.RC200	C2 CO: 700 - 850 mm.
KEN.P300.RC200	C2 CO \geq 900 mm .
KEN.P300.RD200	T2. Right opening.
KEN.P300.RI200	T2. Left opening.
KEN.P390.RC400	C4 CO: 900 mm.
KEN.P395.RC400	C4 CO: 950 - 1150 mm.
KEN.P300.RC400	C4 CO \geq 1200. (Double lock).
KEN.P2IP.RC200	C2. CO: 700-850 mm. IP54.
KEN.P3IP.RC200	C2. CO \geq 900 mm. IP54.
KEN.P3IP.RD200	T2. Right opening. IP54.
KEN.P3IP.RI200	T2. Left opening. IP54.
KEN.P3IP.RC400	C4 CO \geq 1200. (Double lock). IP54.

1.2

DOOR MECHANISM

Springs, synchronization, wheels and buffers

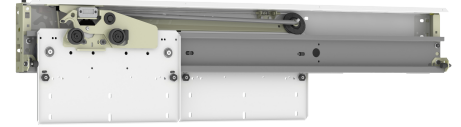

DSR Safety spring fastening support

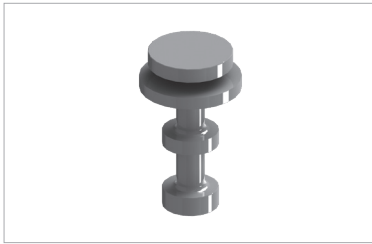

Code	Description
DSR.P300.R0000	Safety spring fastening support.

PFR Wheel



Code	Description
PFR.0700.00000	Synchronization. PFR-07. External Ø 64 mm. Internal Ø 8 mm.
PFR.8400.00000	Concentric. PFR-84. Ø 66 mm.
PFR.6800.00000	Eccentric. PFR-68. Ø 26 mm.
PFR.3700.00000	PFR-37. Ø 39.5 mm.

RSR Safety spring

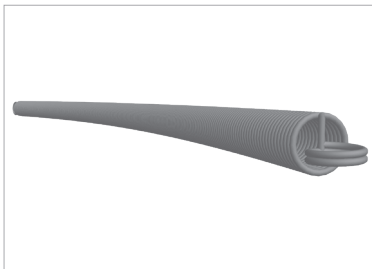

Code	Description
RSR.0000.TD015.00001.575FG.3540	Length: 354 mm.
RSR.0000.TD015.00001.575FG.3740	Length: 374 mm.
RSR.0000.TD015.00001.475FG.3920	Length: 392 mm.
RSR.0000.TD015.00001.575FG.4240	Length: 424 mm.
RSR.0000.TD015.00001.575FG.4250	Length: 425 mm.
RSR.0000.TD015.00001.475FG.4420	Length: 442 mm.
RSR.0000.TD015.00001.575FG.4740	Length: 474 mm.
RSR.0000.TA013.00001.250FG.5600	Length: 560 mm.
RSR.0000.TD015.00001.575FG.5740	Length: 574 mm.
RSR.0000.TA013.00001.250FG.6200	Length: 620 mm.
RSR.0000.TA013.00001.250FG.6850	Length: 685 mm.

 For associate spring length with CO see annexe 5 (Safety spring length table).

PTG Rubber stop

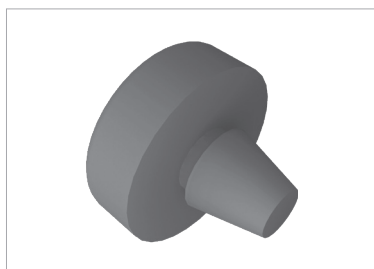

Code	Description
PTG.KL00.S0000	Rubber stop.

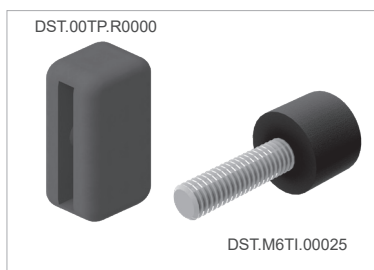

DST Lock beak rubber stop

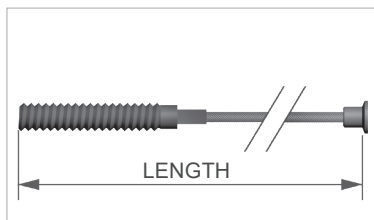

Code	Description
DST.00TP.R0000	Lock beak rubber stop.
DST.M6TI.00025	Rubber stop injected. M6 x 25 mm.
DST-M6TI.00035	Rubber stop injected. M6 x 35 mm.

PCA Synchronization wire



Code	Description
PCA.0000. 	Synchronization wire.
 To complete this code, see annexe 2 (Synchronization wire length by clear opening table). The price shown is valid for one linear metre.	

RCA Tensor spring for synchronization wire

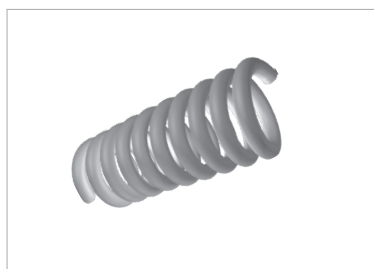

Code	Description
RCA.0000.C0015.00330.925FG.0250	Tensor spring for synchronization wire.

PAM Cable fastening plate



Code	Description
PAM.P3CA.00000	C4, T2. Fast plates.

2

FRAME



PPS Sill

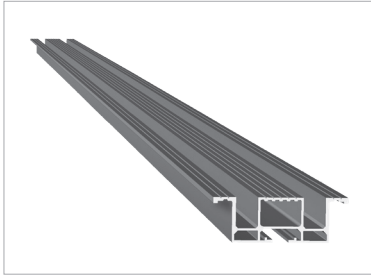

Code	Description
PPS. <input type="text" value="14"/> . <input type="text" value="3"/> .RC2. <input type="text" value="1"/>	C2.
PPS. <input type="text" value="14"/> . <input type="text" value="3"/> .RC4. <input type="text" value="1"/>	C4.
PPS. <input type="text" value="14"/> . <input type="text" value="3"/> .RR2. <input type="text" value="1"/>	T2. Right opening.
PPS. <input type="text" value="14"/> . <input type="text" value="3"/> .RL2. <input type="text" value="1"/>	T2. Left opening.
PPS. <input type="text" value="14"/> . <input type="text" value="3"/> .RT2. <input type="text" value="1"/>	T2. CO: 700, 800, 900. EN 81-20/50.

 For sill without dust holes in telescopic doors the code is completed with T. (For either .Left or Right opening, sill is the same

To complete this code, see annex 1 (Clear opening table), annex 3 (Sill options) and annex 14 (Sill materials, finishes and dimension table). The price shown is valid for PL .800 mm

PSS Sill supplement



Code	Description
PSS.6000.R00 <input type="text" value="7"/> <input type="text" value="1"/>	Width 60 mm.

 To complete this code, see annex 1 (Clear opening table) and annex 7 (Sill finishes .table). The price shown is valid for aluminium sill PL 800 mm

PCF Sill support console

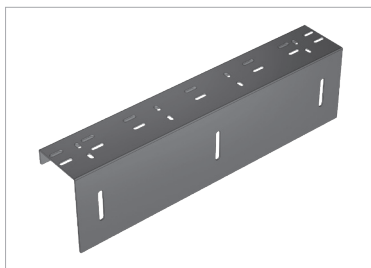

Code	Description
PCF.C3 <input type="text" value="8"/> .R00AL <input type="text" value="1"/>	For AL, AR, HC, XC sill. Load ≤ 3000kg.
PCF.C3 <input type="text" value="8"/> .R00HM <input type="text" value="1"/>	For HM, XM sill. Load ≤ 3000kg.
PCF.C5 <input type="text" value="8"/> .R00AL <input type="text" value="1"/>	For AL, AR, HC, XC sill. 3001 ≤ load ≤ 5000kg.
PCF.C5 <input type="text" value="8"/> .R00HM <input type="text" value="1"/>	For HM, XM sill. 3001 ≤ load ≤ 5000kg.
PCF.C8 <input type="text" value="8"/> .R00AL <input type="text" value="1"/>	For AL, AR, HC, XC sill. 5001 ≤ load ≤ 8000kg.
PCF.C8 <input type="text" value="8"/> .R00HM <input type="text" value="1"/>	For HM, XM sill. 5001 ≤ load ≤ 8000kg.

 To complete this code, see annex 8 (Width) and annex 1 (Clear opening table). The price shown is valid for CO 800 mm. To determine the price, see annex 1.

AES Fastening bracket set

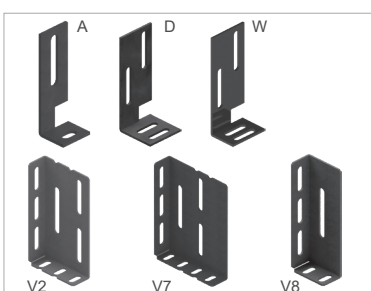

Code	Description
AES.A000.R0000	Type: "A" (1 unit).
AES.D000.R0000	Type: "D" (1 unit).
AES.V200.R0000	Type: "V2" (1 unit).
AES.V700.R0000	Type: "V7" (1 unit).
AES.V800.R0000	Type: "V8" (1 unit).
AES.W000.R0000	Type: "W" (1 unit).

ACJ  **Releaser lock assembly**



Code	Description
ACJ.0000.RD000	C2, T2. Right opening.
ACJ.0000.RI000	T2. Left opening.

ADS  **Triangular key set**



Code	Description
ADS.0011.R0000	Triangular key set (Plastic).
ADS.0071.R0000	Triangular key set (Metallic). L: 710 mm.
ADS.81MK.CT080	Triangular key set (Prudhomme). Chromed. Special hights. L: 80 mm.
ADS.81MK.CT160	Triangular key set (Prudhomme). Chromed. Special hights. L: 160 mm.
ADS.81MK.CT600	Triangular key set (Prudhomme). Chromed. Special hights. L: 600 mm.

DAL  **Counterweight aluminium tube**

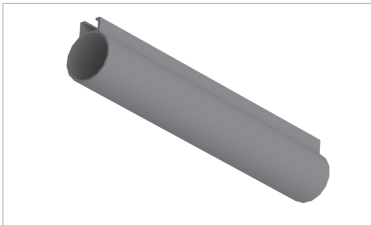

Code	Description
DAL.TC37.R0000. Dimension X	Counterweight aluminium tube Ø 37mm.
 Code Dimension X: The value is HL + 100. For example: HL 2.000 = 2100 (Without dot).	

ACP  **Counterweight accesories**

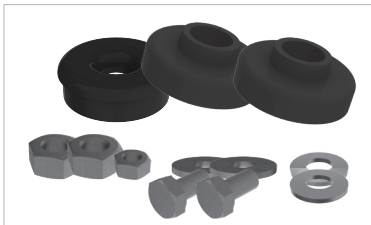

Code	Description
ACP.0037.R0000	Counterweight tube Ø 37mm.

PFA | | **Toe guard**

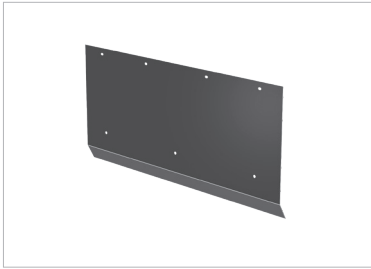

Code	Description
PFA.0000.R00FG <input type="text" value="1"/>	Standard model. Galvanized steel.
PFA.0000.R00 <input type="text" value="6"/> <input type="text" value="1"/>	Standard model. Stainless steel finishes.

To complete this code, see annex 1 (Clear opening table) and annex 6 (Finishes table).
 .The price shown is valid for CO 800 mm

KDM | | **Manual unlocking device**

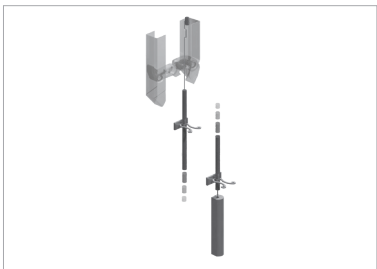

Code	Description
KDM.P3.16.R.0D.000 <input type="text" value="PH"/>	Locking device 160mm. Right opening.
KDM.P3.16.R.0I.000 <input type="text" value="PH"/>	Locking device 160mm. Left & central opening.

.To complete this code, **PH** refers to Panel Height

PDI | | **Header**

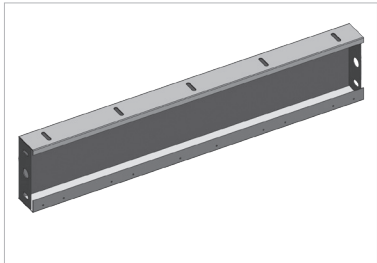

Code	Description
C2	
PDI. <input type="text" value="M"/> 00.RC2 <input type="text" value="6"/> <input type="text" value="1"/> <input type="text" value="17"/> . <input type="text" value="15"/> <input type="text" value="18"/>	Without indicator.
PDI. <input type="text" value="M"/> CS.RC2 <input type="text" value="6"/> <input type="text" value="1"/> <input type="text" value="17"/> . <input type="text" value="15"/> <input type="text" value="18"/>	With indicator.
C4	
PDI. <input type="text" value="M"/> 00.RC4 <input type="text" value="6"/> <input type="text" value="1"/> <input type="text" value="17"/> . <input type="text" value="15"/> <input type="text" value="18"/>	Without indicator.
PDI. <input type="text" value="M"/> CS.RC4 <input type="text" value="6"/> <input type="text" value="1"/> <input type="text" value="17"/> . <input type="text" value="15"/> <input type="text" value="18"/>	With indicator.
T2	
PDI. <input type="text" value="M"/> 00.RT2 <input type="text" value="6"/> <input type="text" value="1"/> <input type="text" value="17"/> . <input type="text" value="15"/> <input type="text" value="18"/>	Without indicator.
PDI. <input type="text" value="M"/> CS.RT2 <input type="text" value="6"/> <input type="text" value="1"/> <input type="text" value="17"/> . <input type="text" value="15"/> <input type="text" value="18"/>	With indicator.

To complete this code, see annex 1 (Clear opening table), annex 6 (Materials and finishes table), annex 17 (Header dimensions table), annex 15 (IP54) and annex 18 (Jamb cabinet table). The price shown is valid for PL 800 mm in epoxy RAL 7032 leatherette standard.

For headers with indicator attach hole position drawing.

For complete the code with below options:

P3: Premium model.

P2: Premium model EI60.

NOTE: For special model contact with commercial department.

CTP |  **Lightcover without release lock**

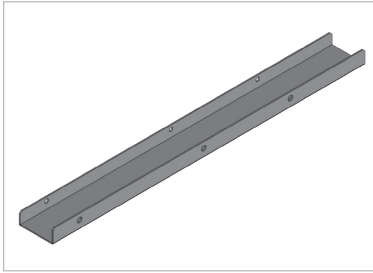

Code	Description
C4	
CTP.0000.RC4 <input type="text" value="16"/> <input type="text" value="6"/> <input type="text" value="1"/>	Standard model.
T2	
CTP.0000.RR2 <input type="text" value="16"/> <input type="text" value="6"/> <input type="text" value="1"/>	Standard model. Right opening.
CTP.0000.RL2 <input type="text" value="16"/> <input type="text" value="6"/> <input type="text" value="1"/>	Standard model. Left opening.
<p> To complete this code, see annex 16 (Intumescent strip), annex 6 (Materials and finishes table) and annex 1 (Clear opening table). The price shown is valid for PL 800 mm in epoxy RAL 7032 leatherette standard</p>	

PTP |  **Lightcover with release lock**

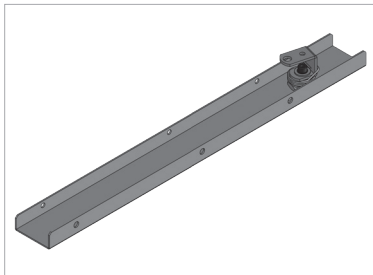

Code	Description
C4	
PTP.00 <input type="text" value="9"/> .RC4 <input type="text" value="16"/> <input type="text" value="6"/> <input type="text" value="1"/>	C4 CO < 950. Standard model.
PTP.50 <input type="text" value="9"/> .RC4 <input type="text" value="16"/> <input type="text" value="6"/> <input type="text" value="1"/>	C4 CO ≥ 950. Standard model.
T2	
PTP.50 <input type="text" value="9"/> .RR2 <input type="text" value="16"/> <input type="text" value="6"/> <input type="text" value="1"/>	Standard model. Right opening.
PTP.50 <input type="text" value="9"/> .RL2 <input type="text" value="16"/> <input type="text" value="6"/> <input type="text" value="1"/>	Standard model. Left opening.
<p> To complete this code, see annex 9 (Light cover contact table), see annex 16 (Intumescent strip), annex 6 (Materials and finishes table) and annex 1 (Clear opening table). The price shown is valid for PL 800 mm in epoxy RAL 7032 leatherette standard and without contact</p>	

3

PANELS



AGH Panel guide shoe assembly

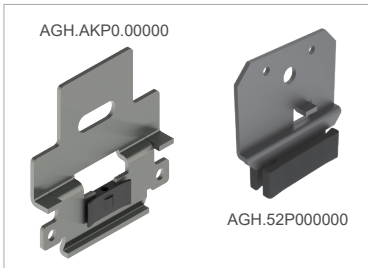

Code	Description
AGH.P0EN.00000	8 mm groove (2 units).
AGH.AKP0.00000	8 mm groove. type plus (Release II) EN 81.20/50. (2 units).
AGH.52P000000	Except full glass in moorings. 15 mm groove (2 units).

GFH

Glass



Code	Description
GFH.GMB0.00000 Dimension X1 Dimension Y1	Laminated glass. Beveled big vision 5+5.
GFH.GME2.00000 Dimension X2 Dimension Y1	Laminated glass. Flush big vision 6 + 6.

! Code Dimension X1: PL / number of panels - 40 mm. Code Dimension Y1: HL - 200 mm.
Code Dimension X2: PL / number of panels - 47 mm. Code Dimension Y1: HL - 200 mm.
Note: In case of obtaining a value of three figures, precede by 0 to complete the code.
The price shown is valid for glass measurements T2, PL 800 mm and HL 2.000 mm, with a ratio of X and Y = 1

4

ELECTRONIC COMPONENTS



KCE Electrical contact kit

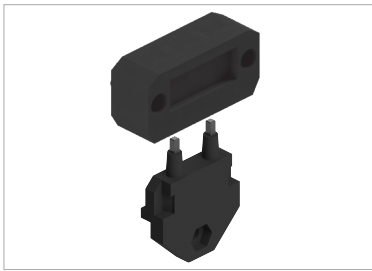

Code	Description
KCE.S4S3.00000	40 mm. (EDC-92 & DCA F3).
KCE.S5S3.00000	50 mm.

CCE Electrical contact with support assembly



Code	Description
CCE.BE00.R0000	Bistable switch electromagnetic assembly (Berstein).
CCE.BEM0.R0000	Bistable switch mechanic assembly (Berstein).
CCE.PR00.RD000	Prudhomme electrical contact. C2. Telescopic right opening.
CCE.PR00.RI000	Prudhomme electrical contact. C4. Telescopic left opening.

PCE Electrical contact

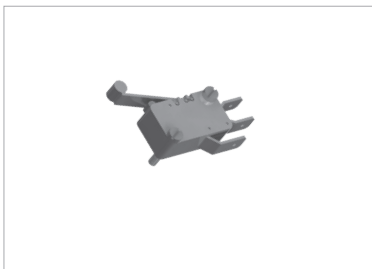

Code	Description
PCE-MECR.00000	Monostable microswitch.

5

ANNEXES

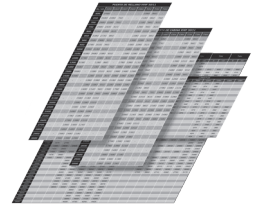

1

CLEAR OPENING TABLE

CO	CODE	RATIO
700	0700	1,00
750	0750	1,00
800	0800	1,00
850	0850	1,06
900	0900	1,13
915	0915	1,14
950	0950	1,19
1.000	1000	1,25
1.050	1050	1,31
1.100	1100	1,38
1.150	1150	1,44
1.200	1200	1,50
1.250	1250	1,56
1.300	1300	1,63
1.350	1350	1,69
1.400	1400	1,75
1.450	1450	1,81
1.500	1500	1,88
1.550	1550	1,94
1.600	1600	2,00
1.650	1650	2,06
1.700	1700	2,13
1.750	1750	2,19
1.800	1800	2,25

CO	CODE	RATIO
1.850	1850	2,31
1.900	1900	2,38
1.950	1950	2,44
2.000	2000	2,50
2.050	2050	2,56
2.100	2100	2,63
2.150	2150	2,69
2.200	2200	2,75
2.250	2250	2,81
2.300	2300	2,88
2.350	2350	2,94
2.400	2400	3,00
2.450	2450	3,06
2.500	2500	3,13
2.550	2550	3,19
2.600	2600	3,25
2.650	2650	3,31
2.700	2700	3,38
2.750	2750	3,44
2.800	2800	3,50
2.850	2850	3,56
2.900	2900	3,63
2.950	2950	3,69
3.000	3000	3,75

To determine the final price it is necessary to multiply the base price by the ratio in the table.

2

SYNCHRONIZATION WIRE LENGTH BY CLEAR OPENING TABLE

PL	CODE / LENGTH					
	C2	C4 ⁽¹⁾	C4 ⁽²⁾	C6	T2	T3
700	02730	-	-	-	01180	-
750	02905	-	-	-	01280	-
800	03070	-	-	-	01280	-
850	03245	-	-	-	01380	-
900	03420	02725	00910	-	01380	-
950	03595	02875	00960	-	01480	-
1.000	03770	03025	01010	-	01480	-
1.050	03945	03175	01080	-	-	-
1.100	04120	03325	01080	-	01580	-
1.150	04295	03475	01080	-	-	-
1.200	04470	-	01140	-	01680	-
1.250	04645	-	-	-	-	-
1.300	04820	-	01180	-	01780	-
1.350	04995	-	-	-	-	-
1.400	05170	-	01180	-	01880	-
1.450	05345	-	-	-	-	-
1.500	05520	-	01280	-	01980	-
1.550	05695	-	-	-	-	-
1.600	05870	-	01380	-	02080	-
1.700	-	-	01380	-	-	-
1.800	-	-	01480	-	-	-
1.900	-	-	01480	-	-	-
2.000	-	-	01480	-	-	-
2.100	-	-	01580	-	-	-
2.200	-	-	01580	-	-	-
2.300	-	-	01680	-	-	-
2.400	-	-	01780	-	-	-
2.500	-	-	01780	-	-	-
2.600	-	-	01780	-	-	-
2.700	-	-	01880	-	-	-
2.800	-	-	01880	-	-	-

• To determine the final price it is necessary to multiply the length x 0,0097.

(1) The dimension is for the synchronization wire between opposite sides of hanger plates.

(2) The dimension is for the synchronization wire between fast and slow hanger plates.

3

SILL OPTIONS

SILL TYPE	CODE	Increase in the final price (€)
With dust holes	0A	6,30 €
Without dust holes	00	-
Heated with dust holes	HA	241,37 €
Heated without dust holes	H0	241,37 €

5

SAFETY SPRING LENGTH TABLE

PL	C2	C4	C6	T2	T3
700	0425	-	-	0354	-
750	0425	-	-	0354	-
800	0425	-	-	0354	-
850	0425	-	-	0374	-
900	0560	0442	-	0374	-
950	0560	0442	-	0374	-
1.000	0560	0442	-	0374	-
1.050	0560	0442	-	0374	-
1.100	0620	0442	-	0424	-
1.150	0620	0392	-	0424	-
1.200	0620	0374	-	0424	-
1.250	0620	0374	-	0424	-
1.300	0620	0374	-	0474	-
1.350	0620	0374	-	0474	-
1.400	0620	0374	-	0474	-
1.450	0685	0374	-	0474	-
1.500	0685	0374	-	0474	-
1.550	0685	0374	-	0474	-
1.600	0685	0374	-	0474	-
1.650	0685	0374	-	-	-
1.700	0685	0374	-	-	-
1.750	0685	0374	-	-	-
1.800	0685	0374	-	-	-
1.850	0685	0374	-	-	-
1.900	0685	0374	-	-	-
1.950	0685	0374	-	-	-
2.000	0685	0374	-	-	-
2.100	-	0374	-	-	-
2.200	-	0374	-	-	-
2.300	-	0424	-	-	-
2.400	-	0424	-	-	-
2.500	-	0424	-	-	-
2.600	-	0474	-	-	-
2.700	-	0474	-	-	-
2.800	-	0474	-	-	-
2.900	-	0474	-	-	-
3.000	-	0474	-	-	-

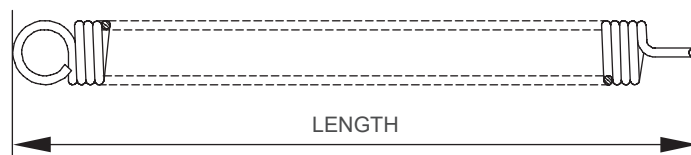

6a

EPOXY FINISHES TABLE

MATERIAL	FINISH	CODE	RATIO	
Epoxy	Leatherette standard	RAL 7032	1	
	Leatherette Other	RAL 9016	IM	75,00€ ¹
		RAL 1013		75,00€ ¹
		RAL 9001		75,00€ ¹
		RAL 7001		75,00€ ¹
		RAL 7010		75,00€ ¹
		RAL 1001		75,00€ ¹
		RAL 7005		75,00€ ¹
		RAL 7012		75,00€ ¹
		RAL 7030		75,00€ ¹
		RAL 7035		75,00€ ¹
		RAL 8017		75,00€ ¹
	RAL 7040	75,00€ ¹		
	Sparkle	PP300		☎
	Textured	Grey		☎
		Grey Metallic		☎

.Increase in the final price¹

6b

STAINLESS STEEL FINISHES TABLE

MATERIAL	FINISH	CODE	RATIO
Stainless steel	AISI 304	XN	2,10
	AISI 441	MX	1,40
	AISI 304 Mirror	B2	2,45
	AISI 441 Mirror	MB	1,40
	Special finishes	AE	☎

.Increase in the final price¹

.To determine the final price it is necessary to multiply the base price by the ratio in the table

7

SILL FINISHES TABLE

	FINISH	CODE	RATIO
S	(Aluminium (16 mm track	AL	1,00
	Reinforced aluminium	AR	1,50
	Sheet metal steel	HC	4,30
	Solid steel	HM	6,80
	Sheet metal stainless steel	XC	5,90
	Solid stainless steel	XM	9,75

.To determine the final price it is necessary to multiply the base price by the ratio in the table
Only finishes marked with a **S** are valid for sill between frames

8

SILL SUPPORT CONSOLE WIDTH TABLE

WIDTH	CODE	(€)
mm 75 - 55	55 - 75	40,04
mm 125 - 80	80 - 125	42,07
mm 170 - 130	130 - 170	73,72
mm 180 - 175	175 - 180	75,90

9

LIGHT COVER CONTACT TABLE

MODEL	CODE	RATIO
Without contact	00	1,00
Monoestable EN 81-21	M2	3,00
Biestable EN 81-21 manual reset	MF	4,00
Biestable EN 81-21 electrical reset	BS	7,00
EN 81-71	PR	10

.To determine the final price it is necessary to multiply the base price by the ratio in the table

14

SILL MATERIALS, FINISHES AND DIMENSION TABLE

MATERIAL	AISI	OPENING	CHANNEL	CODE	DESCRIPTION	HEATED OPTION	RATIO
Aluminium	-	C2	mm 8,2	AL054008	.mm. Panels 50 mm 54	Available	1,00
		C4-T2		AL090008	90 mm. Panels 40 + 40 mm.		1,00
Reinforced aluminium	-	C2	mm 8,2	AR054008	.mm. Panels 50 mm 54		1,50
		C4-T2		AR090008	.mm. Panels 40 + 40 mm 90		1,50
Solid iron	-	C2	mm 14	HM054015	.mm. Panels 50 mm 54	Not available	6,80
		C4-T2	mm 15	HM090015	.mm. Panels 40 + 40 mm 90		6,80
Solid stainless steel	-	C2	mm 14	XM054015	.mm. Panels 50 mm 54		9,75
		C4-T2	mm 15	XM090015	.mm. Panels 40 + 40 mm 90		9,75
Iron metal sheet	-	C2	mm 15	HC054015	.mm. Panels 50 mm 54	Available	4,30
		C4-T2	mm 14,8	HC090015	.mm. Panels 40 + 40 mm 90		4,30
Stainless steel metal sheet	304	C2	mm 15	XC054015	.mm. Panels 50 mm 54		7,07
		C4-T2	mm 14,8	XC090015	.mm. Panels 40 + 40 mm 90		7,07

NOTE: In case of EN 81.20/50 Release II complete at the end of the code R2. (From October 2020)

.To determine the final price it is necessary to multiply the base price by the ratio in the table

15

IP54

OPTION	CODE
Without IP54	00
With IP54	IP

16

INTUMESCENT STRIP

OPTION	CODE	RATIO
Without Intumescent strip	00	1,00
With Intumescent strip	EI	+13 €

17

HEADER DIMENSIONS TABLE

FRAME DEPTH	HEADER HEIGHT	CODE	RATIO
60	80	0080.060	1,15
	100	0100.060	1,15
	210	0210.060	1
	265	0265.060	1,15
155	210	0210.155	1

18

JAMB CABINET TABLE

OPTION	CODE
Door without jamb cabinet	00
Door with jamb cabinet	WI / WD / WF



Sales contacts

General: commercial@klefer.com

www.klefer.com