

PREMIUM PM SPARE PARTS

Automatic horizontal sliding car door

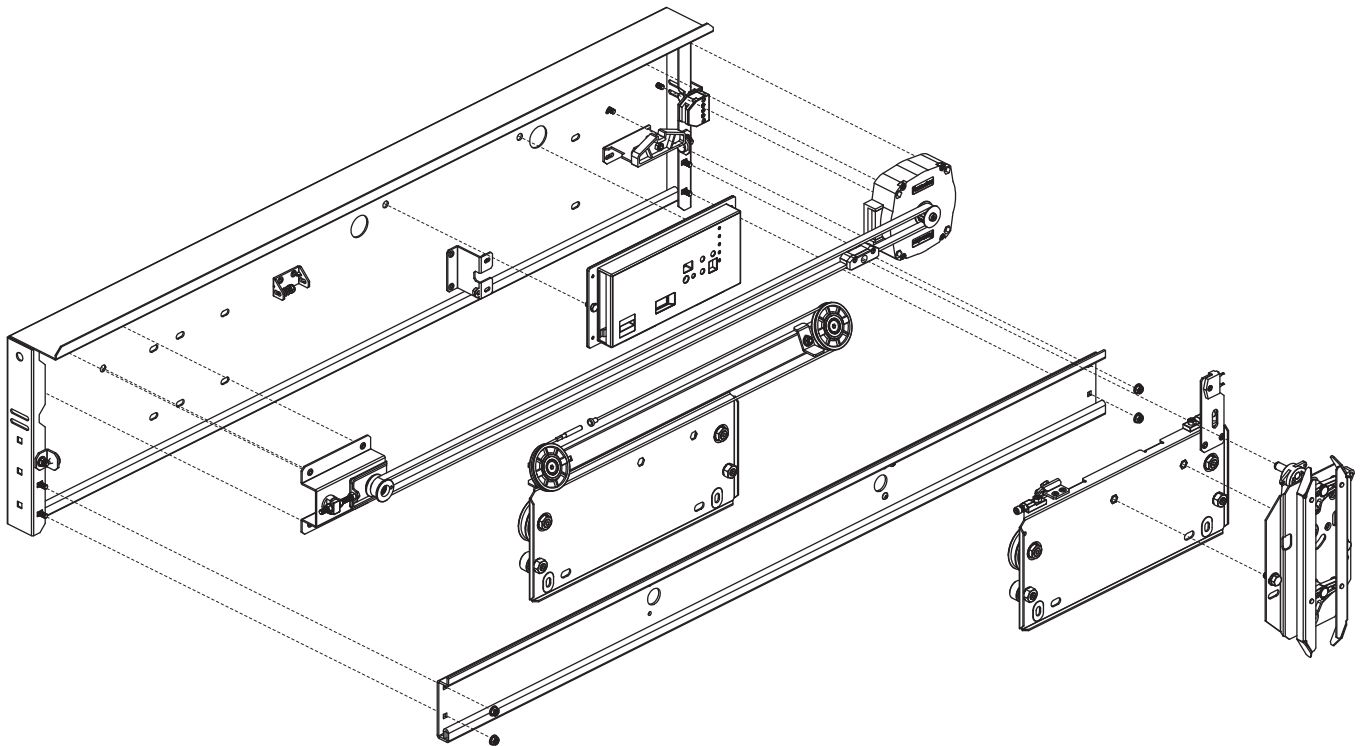

Multimedia design and production by Klefer.

Klefer, S.A.
Kilkis business park.
61100 GR.
Greece.
Hellenic Business Registry No: 14504535000.



- Spare part in stock: Available with a minimal period of delivery.



- Spare parts to be manufactured: Need to be fabricated and therefore requires a longer delivery period.

Klefer reserves the right to modify the specification and price of the products in this catalogue without prior notice.

Rate revision according version.
The rates are valid except for typographical mistakes.
The price of packaging is not included.
IVA or VAT not included.

1.1

DOOR OPERATOR

Traction parts



CMT Motor

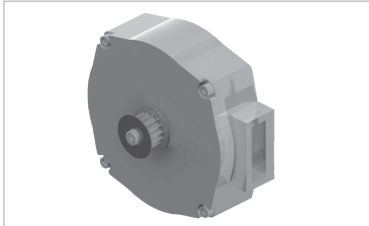

Code	Description
CMT.PME041	With encoder and RPP pulley (From 20/02/2019).
CMT.PME065	With encoder and Eagle pulley (Until 15/02/2019).
CMT.PME055	IP54 with encoder and RPP pulley. (From 20/02/2019).
CMT.PME056	IP54 with encoder and Poly-V pulley.
CMT.PME071	With encoder and Poly-V pulley.

VMT Encoder

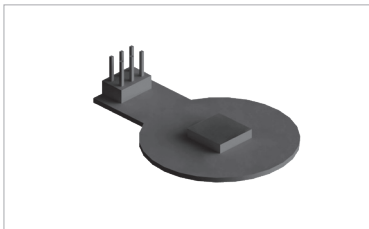

Code	Description
VMT.PMEN.C0000	Encoder (PM Motor).

PPM Motor pulley

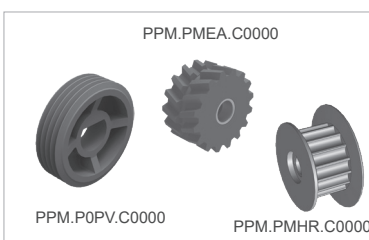

Code	Description
PPM.PMEA.C0000	Eagle model.
PPM.P0PV.C0000	Poly-V model.
PPM.PMHR.C0000	RPP model.

CPM Reduction pulley assembly

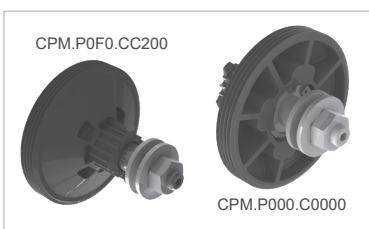

Code	Description
CPM.P0F0.CC200	C2. HTD and Poly-V model.
CPM.P000.C0000	T2. HTD and Poly-V model.

HCO Separator

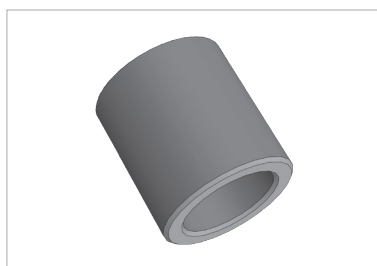

Code	Description
HCO.P0SP.C0000.0000	Separator.

CHT Toothed belt base assembly

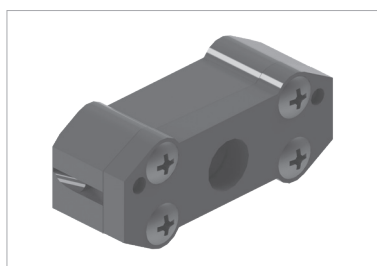

Code	Description
CHT.PMEA.C0000	Eagle toothed belt base assembly.
CHT.VFRF.C0000	HTD 5M & RPP5 toothed belt base assembly (Reinforced).

BOC Poly-V toothed belt



Code	Description
BOC.PV6J.014AP.0483	Poly-V toothed belt.

BHT RPP5 toothed belt by opening door



Code	Description
BHT.P0RP.CC200 <input type="text" value="1"/>	C2.
BHT.P0RP.CT200 <input type="text" value="1"/>	T2.
 To complete this code, see annexe 1 (Clear opening table). The price shown is valid for CO 800 mm	

BHT RPP5 toothed belt by meters



Code	Description
BHT.P0RP.C0000 <input type="text" value="Quantity"/>	Toothed belt RPP5.
 .In Quantity field, show the meters needed preceded by 0 until complete 4 figures .The price shown is valid for one meter	

BHT 

Eagle toothed belt opening door

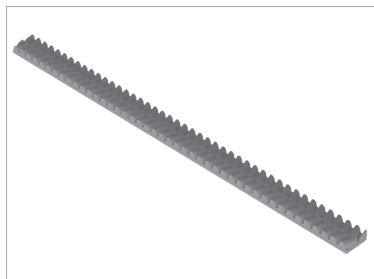

Code	Description
BHT.P0EA.CC200 <input type="text" value="1"/>	C2.
BHT.P0EA.CT200 <input type="text" value="1"/>	T2.

 To complete this code, see annex 1 (Clear opening table). The price shown is valid for PL 800 mm

BHT 

Eagle toothed belt by metres

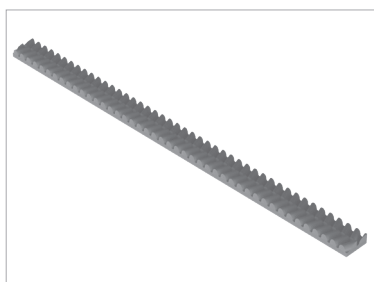

Code	Description
BHT.P0EA.C0000 <input type="text" value="Quantity"/>	Eagle Toothed belt.

 .In Quantity field, show the meters needed preceded by 0 until complete 4 figures
 .The price shown is valid for one meter

1.2

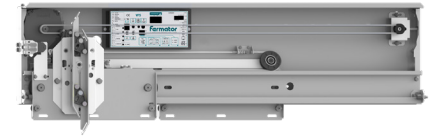

DOOR OPERATOR

Synchronization

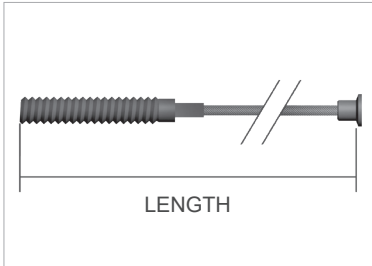

PCA Synchronization wire



Code	Description
PCA.00PL.  ②	Synchronization wire (plastic coated).
 To complete this code, see annex 2 (Shynchronization wire length by clear opening table). The price shown is valid for one metre.	

PAM Cable fastening plate



Code	Description
PAM.P3CA.00000	C4, T2. Fast plates.

PPR Idle pulley

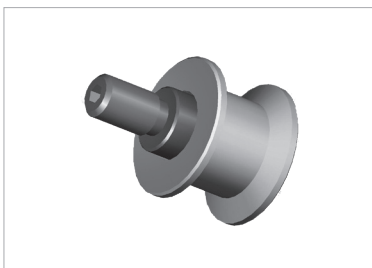

Code	Description
PPR.VF00.C0000	Idle pulley.

RCA Tensor spring for synchronization wire

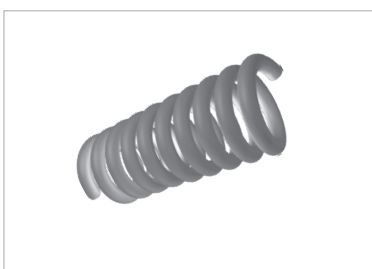

Code	Description
RCA.0000.C0015.00330.925FG.0250	Tensor spring for synchronization wire.

1.3

DOOR OPERATOR

Acting parts



CSK Symmetric clutch assembly

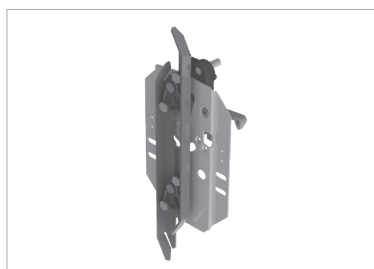

Code	Description
Standard	
CSK.P000.CI000	C2 with reduction, T2. Left opening.
CSK.P0IZ.CC200	C2 without reduction.
CSK.P000.CD000	C2 with reduction, T2. Right opening.
CSK.10A1.CI200	T2 Operation zone 100 mm. Left opening.
CSK.10A1.CD200	T2 Operation zone 100 mm. Right opening.
Pre-opening	
CSK.10AA.CI200	T2. Pre-opening. Left opening.
CSK.10AA.CD200	T2. Pre-opening. Right opening.

CSK Asymmetric clutch assembly



Code	Description
Standard	
CSK.P0AS.CI000	T2. Left opening.
CSK.P0AS.CC200	C2 without reduction.
CSK.P0AS.CD000	T2. Right opening.

CDL Symmetric contact and lock clutch assembly

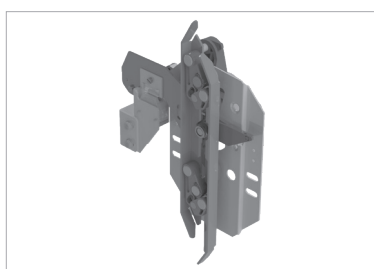

Code	Description
IP21	
CDL.P0AA.C2000	C2 CO \geq 1.450 mm.
CDL.P000.CC200	C2 CO \leq 1.400 mm.
CDL.1000.CI200	T2. Left opening.
CDL.1000.CD200	T2. Right opening.
Pre-opening IP21	
CDL.P0AA.CI000	T2. Left opening.
CDL.P0AA.CD000	T2. Right opening.

CDL Asymmetric contact and lock clutch assembly

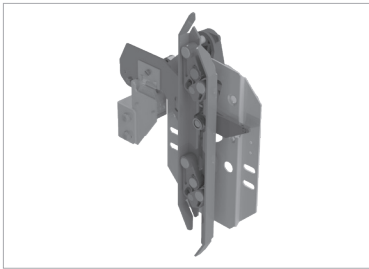

Code	Description
IP21	
CDL.P0A0.CI200	T2. Left opening.
CDL.P0A0.CD200	T2. Right opening.
CDL.P0AS.CC200	C2. CO ≤ 1.400 mm.

KLA Drive fixed cam assembly

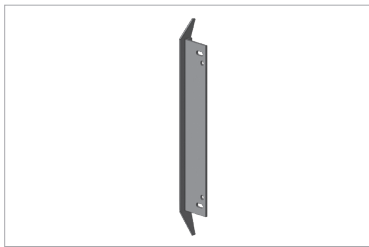

Code	Description
KLA.LX00.CI000	Flexible fixed. Left hand.
KLA.LX00.CD000	Flexible fixed cam. Right hand.

KLA Drive lateral cam kit



Code	Description
KLA.RIPM.CI000 <input checked="" type="checkbox"/>	Left opening.
KLA.RIPM.CD000 <input checked="" type="checkbox"/>	Right opening.
KLA.RIP3.CI000 <input checked="" type="checkbox"/>	Inverted lateral cam assembly. Left hand.
KLA.RIP3.CD000 <input checked="" type="checkbox"/>	Inverted lateral cam assembly. Right hand.

 Code X: Drive height in mm from the centre of the cam to the sill. If standard (1.850 mm), indicate 1850. For other heights increase in 100 by 100 mm.

PTR Stopping retainer

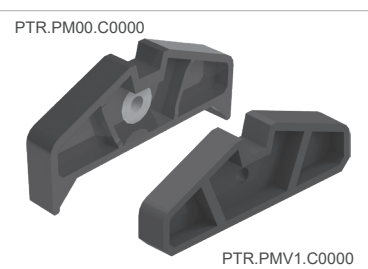

Code	Description
PTR.PM00.C0000	From 2013.
PTR.PMV1.C0000	Until 2013.

DSK Pulling trigger

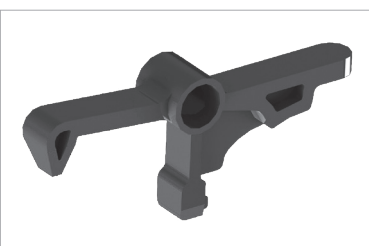

Code	Description
DSK.P0GA.C0000	Pulling trigger.

RTR  **Stopping retainer spring**

Code	Description
RTR.0000.C0008.00450.910ZN.0240	Clutch pulling trigger spring tensor.

REM  **Spring**

Code	Description
REM.OC00.C0035.01002.800FG.0420	For models with reduction (42 mm).

DPL  **Spring seating**

Code	Description
DPL.ECAS.P0000	Spring seating.

1.4

DOOR OPERATOR

Carriages



PFR



Wheel

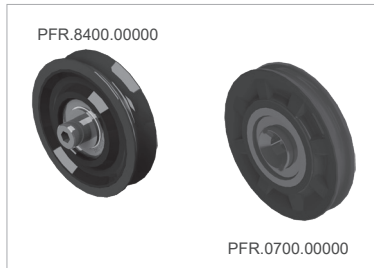

Code	Description
PFR.0700.00000	Synchronization. PFR-07. External Ø 64 mm. Internal Ø 8 mm.
PFR.8400.00000	Concentric. PFR-84. Ø 66 mm.
PFR.4300.00000	Synchronization. PFR-43. External Ø 47 mm. Internal Ø 6,2 mm.
PFR.6800.00000	Eccentric. PFR-68. Ø 26 mm.

PSA



Carriage pulling support



Code	Description
PSA.P000.CT2BC	T2.

1.5

DOOR OPERATOR

Others



KDM Unlocking device kit

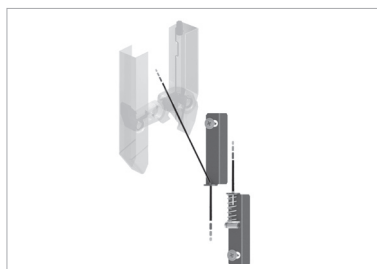

Code	Description
KDM.P0.00.C.0D.000. PH	Right opening.
KDM.P0.00.C.0I.000. PH	Left & central opening.
 .To complete this code, PH refers to Panel Height	

UHT Belt regulation tool



Code	Description
UHT-VF00.C0000	Belt regulation tool.

AEC Fastening bracket set

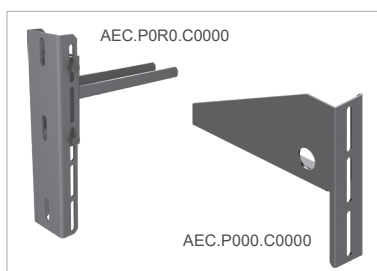

Code	Description
AEC.P0E8.C0000	Adjustable mounting bracket. Model: ER-80. CH+60 ≤ Car operator height ≤ CH+103 (2 units).
AEC.P000.C0000	Fix mounting bracket. Model: EF. CH+175 ≤ Car operator height ≤ CH+216 (2 units).
AEC.P0EG.C0000	Adjustable mounting bracket. Model: EG. CH+264 ≤ Car operator height ≤ CH+410 (2 units).
AEC.P0ER.C0000	Adjustable fixation bracket. Model: ER. CH+104 ≤ Car operator height ≤ CH+174 and CH+217 ≤ Car operator height ≤ CH+263 (2 units).
AEC.P0GP.C0000	Adjustable fixation bracket. Model: EG-Plus. CH+264 ≤ Car operator height ≤ CH+410 (2 units).
AEC.P0RP.C0000	Adjustable fixation bracket. Model: ER-Plus. CH+104 ≤ Car operator height ≤ CH+174 and CH+217 ≤ Car operator height ≤ CH+263 (2 units).

DST**Lock beak rubber stop**

Code	Description
DST.00TP.R0000	Lock beak rubber stop.
DST.M6TI.R0025	Lock beak rubber stop M6x25.
DST.M6TI.R0035	Lock beak rubber stop M6x35.

2

ACCESSORIES



PPS Sill

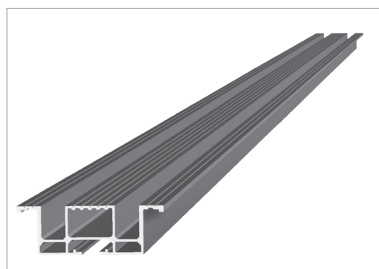

Code	Description
PPS. (14) . (3) .CC2. (1)	C2.
PPS. (14) . (3) .CR2. (1)	T2. Right opening.
PPS. (14) . (3) .CL2. (1)	T2. Left opening.
PPS. (14) . (3) .CT2. (1)	T2. CO: 700, 800, 900. EN 81-20/50.

 For sill without dust holes in telescopic doors the code is completed with T. (For either .(Left or Right opening, sill is the same

To complete this code, see annex 1 (Clear opening table), annex 3 (Sill options) and annex 14 (Sill materials, finishes and dimension table). The price shown is valid for PL .800 mm

PAC Sill support

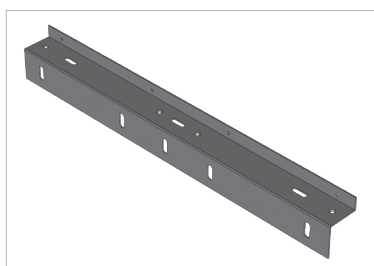

Code	Description
PAC.0054.CC2IM. (1)	For 54 mm sill, without evacuation slots.
PAC.0090.CT2IM. (1)	For 90 mm sill, without evacuation slots.

 To complete this code, see annexe 1 (Clear opening table). The price shown is valid for CO 800 mm.

PFA Toe guard

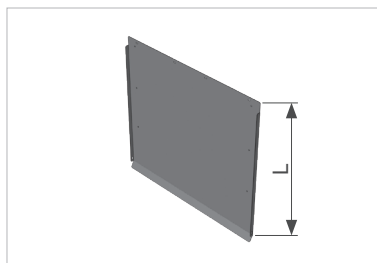

Code	Description
PFA.GM00.C00IM (1)	L: 750 mm. Epoxy.
PFA.GM00.C00XN (1)	L: 750 mm. Stainless steel.

 To complete this code, see annexe 1 (Clear opening table). The price shown is valid for CO 800 mm.

3

PANELS

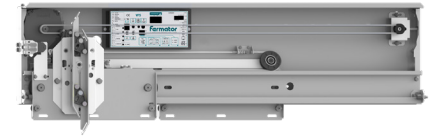

ASH Panel regulator assembly



Code	Description
ASH.SL85.C0000	Height 85mm. (2 units).

AGH Panel guide shoe assembly

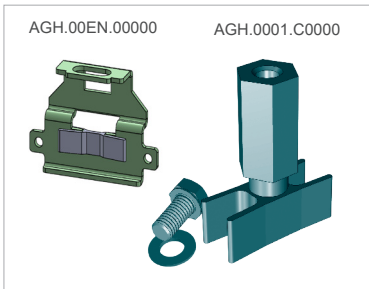

Code	Description
AGH.0001.C0000	16 mm groove (2 units).
AGH.00EN.00000	8 mm groove. EN 81.20/50 (2 units).
AGH.AJP0.00000	8 mm groove. Type plus (Release II) EN 81.20/50 (2 units).

GFH Glass



Code	Dimension X ₁	Dimension Y ₁	Description
GFH.GMB0.00000			Laminated glass. Beveled big vision 5+5.
GFH.GME2.00000			Laminated glass. Flush big vision 6 + 6.

! Code Dimension X₁: CO / number of panels - 40 mm. Code Dimension Y₁: HL - 200 mm.
 Code Dimension X₂: CO / number of panels - 47 mm. Code Dimension Y₁: HL - 200 mm.
 Note: In case of obtaining a value of three figures, precede by 0 to complete the code.
 The price shown is valid for glass measurements T2, PL 800 mm and HL 2.000 mm, with a ratio of X and Y = 1

4

ELECTRONIC COMPONENTS



WCE Electrical wiring



Code	Description
WCE.EN00.S52A2.1500	Encoder. Motor PM. L: 1500mm.
WCE.EN00.S52A4.0400	Encoder. Motor PM. L: 400 mm.
WCE.MT00.S42HK.0400	Motor PM. L: 400 mm.
WCE.MT00.S42HK.1500	Motor PM. L: 1500 mm.
WCE.MTAN.A42HK.0470	Motor PM. Electronic module VF7+. L: 400 mm.
WCE.MTAN.A42HK.1300	Motor PM. Electronic module VF7+ . L: 1300 mm.

CFT Optical safety devices



Code	Description
CFT.FC00.C0000	Photocell. 3.000 mm wire length.
CFT.FCDM.C0000	Photocell. 5.000 mm wire length.

KCE Contact and electrical bridge kit

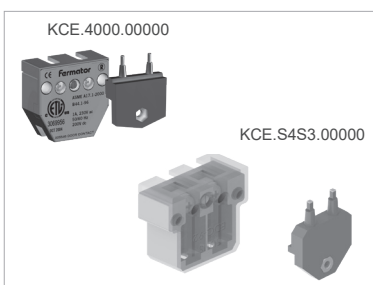

Code	Description
KCE.4000.00000	40 mm.
KCE.S4S3.00000	(EDC-92 + DCA-F3). 40 mm.
KCE.S5S3.00000	(EDC-61 + DCA-F3). 50 mm.

VCI  **VF5+ Electronic module**



Code	Description
VCI.V05P.0010.0FLGE	10 Ohms. EN 81-1/2. Left opening. Greek - English.
VCI.V05P.0010.0FRGE	10 Ohms. EN 81-1/2. Right opening. Greek - English.
VCI.V05P.0010.0FLTE	10 Ohms. EN 81-1/2. Left opening. Turkish - English.
VCI.V05P.0010.0FRTE	10 Ohms. EN 81-1/2. Right opening. Turkish - English.
VCI.V05P.0E10.0FLGE	10 Ohms. EN 81-20/50. Left opening. Greek - English.
VCI.V05P.0E10.0FRGE	10 Ohms. EN 81-20/50. Right opening. Greek - English.
VCI.V05P.0E10.0FLTE	10 Ohms. EN 81-20/50. Left opening. Turkish - English.
VCI.V05P.0E10.0FRTE	10 Ohms. EN 81-20/50. Right opening. Turkish - English.

VCI  **VF7+ Relay Electronic module**



Code	Description
VCI.V07P.0E10.0FLGE	10 Ohms. EN 81.20/50. Left opening. Greek - English.
VCI.V07P.0E10.0FRGE	10 Ohms. EN 81.20/50. Right opening. Greek - English.
VCI.V07P.0E10.0FLTE	10 Ohms. EN 81.20/50. Left opening. Turkish - English.
VCI.V07P.0E10.0FRTE	10 Ohms. EN 81.20/50. Right opening. Turkish - English.

VCI  **VF7+ CAN Electronic module**



Code	Description
VCI.V07P.0E1P.0FLEE	Type CAN . EN 81.20/50. Left opening. Spanish - English.
VCI.V07P.0E1P.0FREE	Type CAN . EN 81.20/50. Right opening. Spanish - English.

VCI  **Emergency power supply**



Code	Description
VCI.AESB.C00GE	Without battery. Greek - English.
VCI.AESB.C00TE	Without battery. Turkish - English.

COE Battery



Code	Description
COE.BAT0.2A000	12 V. 2 A.

VCP Programming console



Code	Description
VCP.VFCP.C00EN	Programming console. English language.

BCV Connector

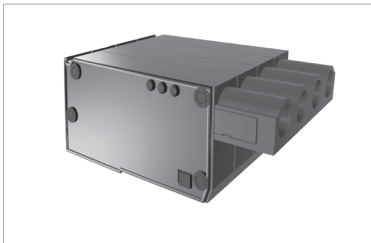

Code	Description
BCV.CO00.S0502	5 mm and 2 paths.
BCV.CO00.S0504	5 mm and 4 paths.
BCV.CO00.S0505	5 mm and 5 paths.
BCV.CO00.S0512	5 mm and 12 paths.
BCV.CO00.S103H	10 mm and 3 paths.

COE Fuse



Code	Description
COE.FU4A.00000	4 A ceramic fuse.

5

ANNEXES

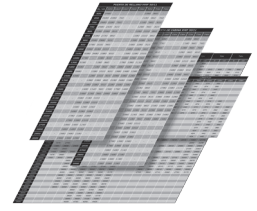

1

CLEAR OPENING TABLE

PL	CODE	RATIO
600	0600	1,00
650	0650	1,00
700	0700	1,00
750	0750	1,00
800	0800	1,00
850	0850	1,06
900	0900	1,13
915	0915	1,14
950	0950	1,19
1.000	1000	1,25
1.050	1050	1,31
1.100	1100	1,38
1.150	1150	1,44
1.200	1200	1,50
1.250	1250	1,56
1.300	1300	1,63
1.350	1350	1,69
1.400	1400	1,75

.To determine the final price, is necessary multiply the base price by the ratio in the table

2

SYNCHRONIZATION WIRE LENGTH BY CLEAR OPENING TABLE

PL	CODE / LENGTH	
	C2	T2
600	02280	01080
650	02480	01080
700	02580	01180
750	02780	01180
800	02980	01280
850	02980	01280
900	03280	01380
950	03480	01480
1.000	03680	01480
1.100	03980	01580
1.200	04380	01680
1.300	04680	-
1.400	05040	-

.To determine the final price it is necessary to multiply the length x 0,0097

3

SILL OPTIONS

SILL TYPE	CODE	Increase in the final price (€)
With dust holes	0A	6,30 €
Without dust holes	00	-
Heated with dust holes	HA	241,37 €
Heated without dust holes	H0	241,37 €
Cut for semiautomatic outside with dust holes	RA	75 €
Cut for semiautomatic outside without dust holes	RO	75 €
Cut for cabin frame with dust holes*	CA	75 €
Cut for cabin frame without dust holes*	CO	75 €

.Only for Telescopic doors *

14

SILL MATERIALS, FINISHES AND DIMENSION TABLE

MATERIAL	AISI	OPENING	CHANNEL	CODE	DESCRIPTION	HEATED OPTION	RATIO
Aluminium	-	C2	mm 8,2	AL054008	.mm. Panels 50 mm 54	Available	1,00
				AL090008	90 mm. Panels 40 + 40 mm.		1,00
		T2	mm 15	AL070015	70 mm. Panels 30 + 30 mm.		1,00
				A2070008	70 mm. Panels 30 + 30 mm. Height 20mm.		1,00
				A8070008	70 mm. Panels 30 + 30 mm. Height 30mm.		1,00
Reinforced aluminium	-	C2	mm 8,2	AR054008	.mm. Panels 50 mm 54	Not available	1,50
				AR090008	.mm. Panels 40 + 40 mm 90		1,50
Solid iron	-	C2	mm 14	HM054015	.mm. Panels 50 mm 54	Not available	6,80
				HM090015	.mm. Panels 40 + 40 mm 90		6,80
Solid stainless steel	-	C2	mm 14	XM054015	.mm. Panels 50 mm 54	Not available	9,75
				XM090015	.mm. Panels 40 + 40 mm 90		9,75
Iron metal sheet	-	C2	mm 15	HC054015	.mm. Panels 50 mm 54	Available	4,30
				HC090015	.mm. Panels 40 + 40 mm 90		4,30
		T2	mm 14,8	HC070015	.mm. Panels 30 + 30 mm 70	Available	4,30
mm 15	XC054015			.mm. Panels 50 mm 54	7,07		
	Stainless steel metal sheet	304	C2	mm 14,8	XC090015	.mm. Panels 40 + 40 mm 90	7,07

NOTE: In case of EN 81.20/50 Release II complete at the end of the code R2. (From October 2020)

.To determine the final price it is necessary to multiply the base price by the ratio in the table



Sales contacts

General: commercial@klefer.com

www.klefer.gr